



# Dell™ Vostro™ 3700 Service Manual

[Working on Your Computer](#)  
[Specifications](#)  
[Removing and Replacing Parts](#)  
[System Setup](#)  
[Diagnostics](#)

---

## Notes, Cautions, and Warnings

-  **NOTE:** A NOTE indicates important information that helps you make better use of your computer.
-  **CAUTION:** A CAUTION indicates potential damage to hardware or loss of data if instructions are not followed.
-  **WARNING:** A WARNING indicates a potential for property damage, personal injury, or death.

If you purchased a Dell™ n Series computer, any references in this document to Microsoft® Windows® operating systems are not applicable.

---

Information in this document is subject to change without notice.  
© 2010 Dell Inc. All rights reserved.

Reproduction of this material in any manner whatsoever without the written permission of Dell Inc. is strictly forbidden.

Trademarks used in this text: *Dell*, the *DELL* logo, and *Vostro* are trademarks of Dell Inc.; *Intel* and *Core* are either trademarks or registered trademarks of Intel Corporation; *Microsoft*, *Windows*, *Windows Vista*, and the *Windows Vista* start button are either trademarks or registered trademarks of Microsoft Corporation in the United States and/or other countries; *Bluetooth* is a registered trademark of Bluetooth SIG, Inc.

Other trademarks and trade names may be used in this document to refer to either the entities claiming the marks and names or their products. Dell Inc. disclaims any proprietary interest in trademarks and trade names other than its own.

February 2010 Rev. A00

[Back to Contents Page](#)

## Audio Board

Dell™ Vostro™ 3700 Service Manual

**WARNING:** Before working inside your computer, read the safety information that shipped with your computer. For additional safety best practices information, see the Regulatory Compliance Homepage at [www.dell.com/regulatory\\_compliance](http://www.dell.com/regulatory_compliance).

---

### Removing the Audio Board



1. Follow the procedures in [Before Working Inside Your Computer](#).
2. Remove the [battery](#).
3. Remove the [base cover](#).
4. Remove the [hard drive assembly](#).
5. Remove the [optical drive](#).
6. Remove the [keyboard](#).
7. Remove the [palm rest](#).
8. Remove the screw that secures the audio board to the palm rest.



9. Open the clip that secures the audio board cable to its connector on the audio board.



10. Disconnect the audio board cable from its connector on the audio board.

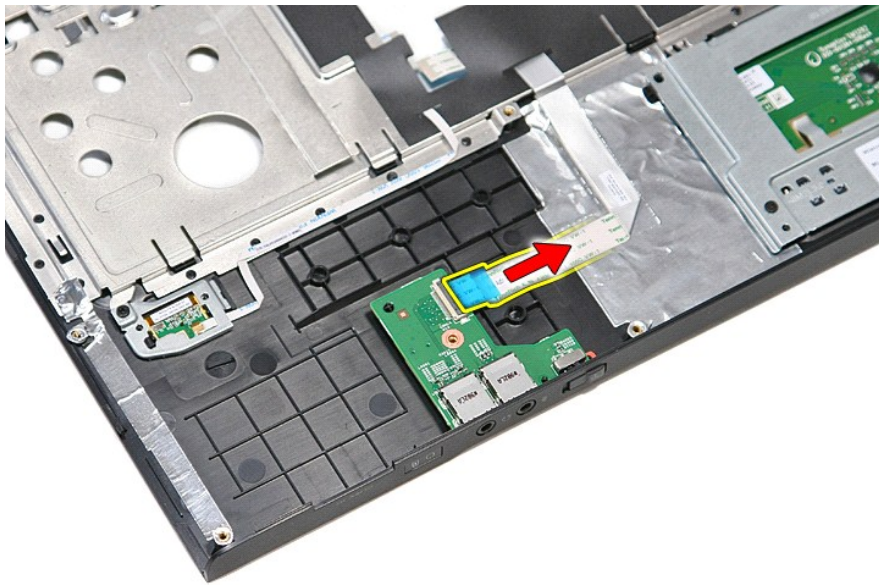

11. Lift the audio board up and away from the computer.

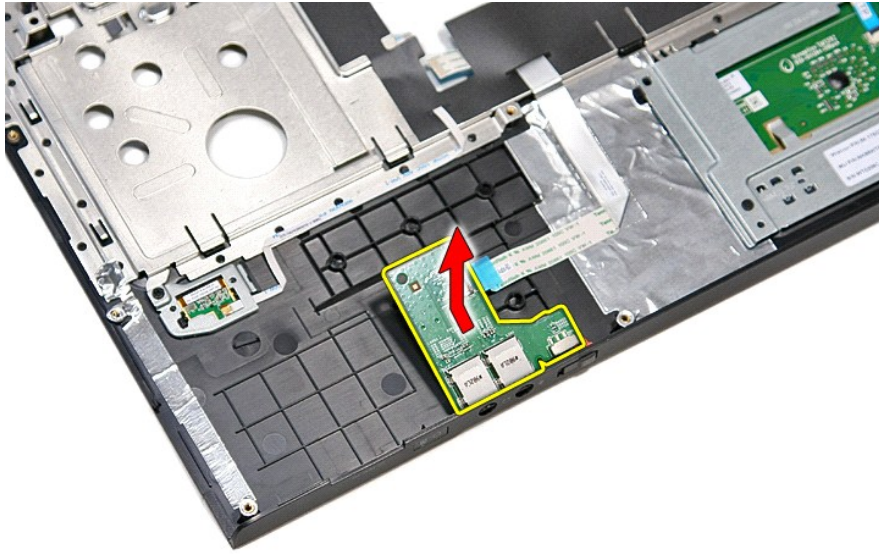

### Replacing the Audio Board

To replace the audio board, perform the above steps in reverse order.

---

[Back to Contents Page](#)

[Back to Contents Page](#)

## Base Cover

Dell™ Vostro™ 3700 Service Manual

**WARNING:** Before working inside your computer, read the safety information that shipped with your computer. For additional safety best practices information, see the Regulatory Compliance Homepage at [www.dell.com/regulatory\\_compliance](http://www.dell.com/regulatory_compliance).

---

### Removing the Base Cover

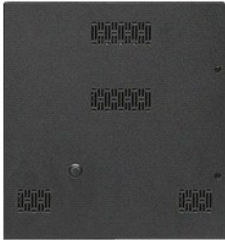

1. Follow the procedures in [Before Working Inside Your Computer](#).
2. Remove the [battery](#).
3. Remove the screws that secure the base cover to the computer.



4. Lift up the base cover and remove it from the computer.

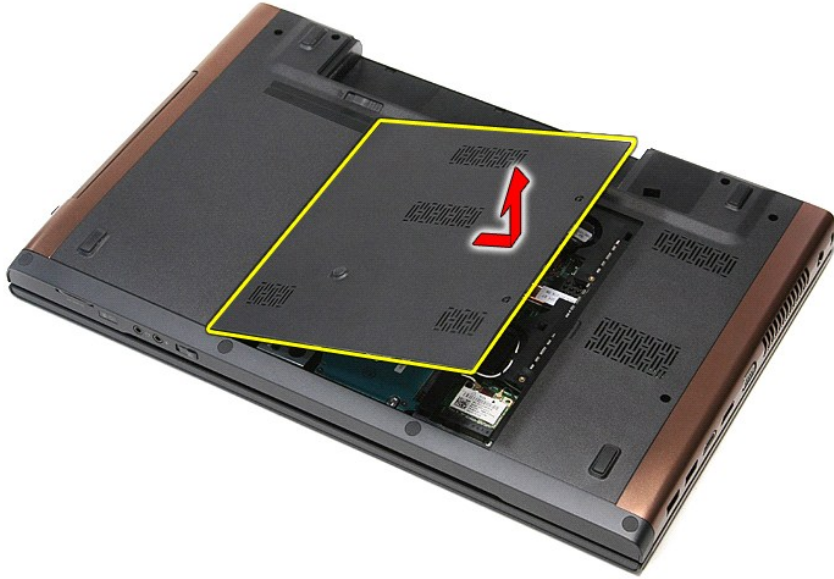

### Replacing the Base Cover

To replace the base cover, perform the above steps in reverse order.

---

[Back to Contents Page](#)

[Back to Contents Page](#)

## Battery

Dell™ Vostro™ 3700 Service Manual

**WARNING:** Before working inside your computer, read the safety information that shipped with your computer. For additional safety best practices information, see the Regulatory Compliance Homepage at [www.dell.com/regulatory\\_compliance](http://www.dell.com/regulatory_compliance).

---

### Removing the Battery



**NOTE:** You may need to install Adobe® Flash® Player from [Adobe.com](http://Adobe.com) in order to view the illustrations below.

1. Follow the procedures in [Before Working Inside Your Computer](#).
2. Flip the computer over.
3. Slide the battery release latch to the unlock position.

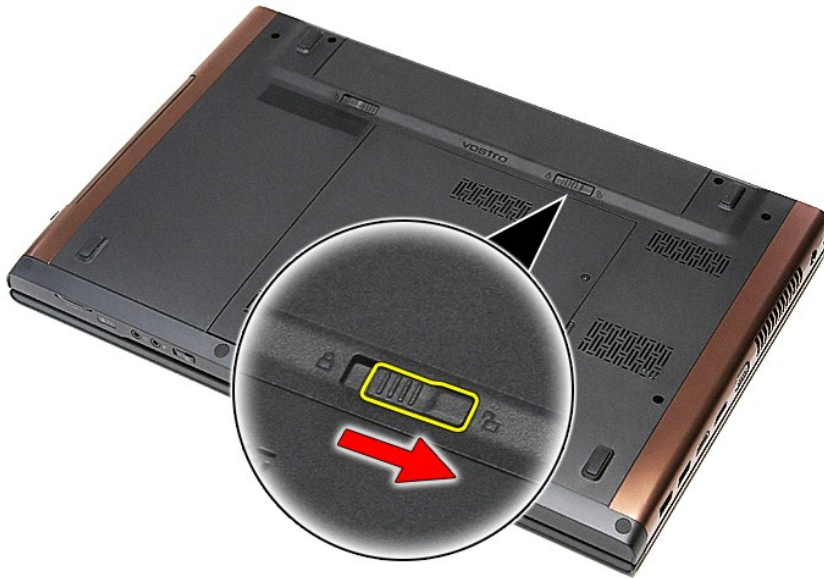

4. Slide the other battery release latch to the unlock position.

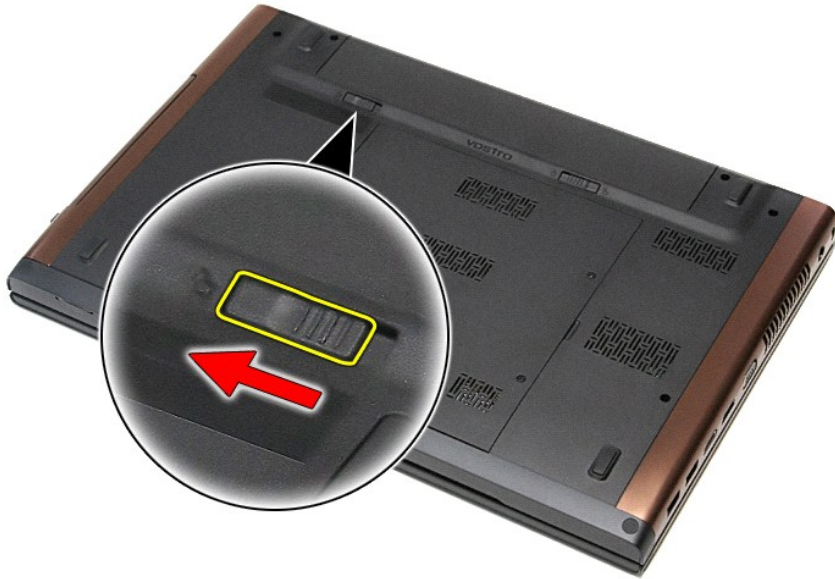

5. Slide the battery and remove it from the computer.



## Replacing the Battery

To replace the battery, perform the above steps in reverse order.

---

[Back to Contents Page](#)



# System Setup

Dell™ Vostro™ 3700 Service Manual

- [Overview](#)
- [Entering System Setup](#)
- [System Setup Screens](#)
- [System Setup Options](#)

## Overview

Use System Setup as follows:

- 1 To change the system configuration information after you add, change, or remove any hardware in your computer
- 1 To set or change a user-selectable option such as the user password
- 1 To read the current amount of memory or set the type of hard drive installed

Before you use System Setup, it is recommended that you write down the System Setup screen information for future reference.

 **CAUTION:** Unless you are an expert computer user, do not change the settings for this program. Certain changes can cause your computer to work incorrectly.

## Entering System Setup

1. Turn on (or restart) your computer.
2. When the blue DELL™ logo is displayed, you must watch for the F2 prompt to appear.
3. Once this F2 prompt appears, press <F2> immediately.

 **NOTE:** The F2 prompt indicates that the keyboard has initialized. This prompt can appear very quickly, so you must watch for it to display and then press <F2>. If you press <F2> before you are prompted, this keystroke will be lost.

4. If you wait too long and the operating system logo appears, continue to wait until you see the Microsoft® Windows® desktop. Then, shut down your computer and try again.

## System Setup Screens

<b>Menu</b> — Appears on top of the System Setup window. This field provides a menu to access the System Setup options. Press < Left Arrow > and < Right Arrow > keys to navigate. As a <b>Menu</b> option is highlighted, the <b>Options List</b> lists the options that define the hardware installed on your computer.		
<b>Options List</b> — Appears on the left side of the System Setup window. The field lists features that define the configuration of your computer, including installed hardware, power conservation, and security features.  Scroll up and down the list with the up- and down-arrow keys. As an option is highlighted, the <b>Options Field</b> displays the option's current and available settings.	<b>Options Field</b> — Appears on the right side of <b>Options List</b> and contains information about each option listed in the <b>Options List</b> . In this field you can view information about your computer and make changes to your current settings.  Press <Enter> to make changes to your current settings. Press <ESC> to return to the <b>Options List</b> .  <b>NOTE:</b> Not all settings listed in the Options Field are changeable.	<b>Help</b> — Appears on the right side of the System Setup window and contains help information about the option selected in <b>Options List</b> .
<b>Key Functions</b> — Appears below the <b>Options Field</b> and lists keys and their functions within the active system setup field.		

Use the following keys to navigate through the System Setup screens:

Keystroke	Action
< F2 >	Displays information on any selected item in the System Setup.
< Esc >	Exit from current view or switch the current view to the <b>Exit</b> page in the System Setup.
< Up Arrow > or < Down Arrow >	Select an item to display.
< Left Arrow > or < Right Arrow >	Select a menu to display.
- or +	Change existing item value.
< Enter >	Select the sub menu or execute command.
< F9 >	Load setup default.
< F10 >	Save current configuration and exit System Setup.

## System Setup Options

## Main

The Main tab lists out the primary hardware features of the computer. The table below defines the function of each option.

Main	
System	Displays the computer model number.
Dell Bios Version Name	Displays the BIOS revision.
System Date	Resets the date on the computer's internal calendar.
System Time	Resets the time on the computer's internal clock.
Processor Type	Displays the type of processor.
Processor Cores	Displays the number of processor cores.
Processor ID	Displays the processor ID.
Processor Speed	Displays the speed of the processor.
Processor Minimum Clock Speed	Displays the minimum clock speed of the processor.
Processor Maximum Clock Speed	Displays the maximum clock speed of the processor.
L2 Cache Size	Displays the processor L2 cache size.
L3 Cache Size	Displays the processor L3 cache size.
System Memory	Displays the total computer memory.
Memory Speed	Displays the memory speed.
Memory Channel Mode	Displays the channel mode (single or dual channel).
DIMM A Size	Displays the size of memory installed on the DIMM slot A.
DIMM B Size	Displays the size of memory installed on the DIMM slot B.
Internal HDD	Displays the model number of the hard drive.
Fixed Bay Device	Displays the model number of the drive in the fixed bay.
Video Controller	Displays the model number of the video card installed on your computer.
Video BIOS Version	Displays the BIOS version of the video card.
Video Memory	Displays the video memory size.
Panel Type	Displays the display panel type.
Native Resolution	Displays the native resolution of the display.
Audio Controller	Displays the type of the audio controller installed on your computer.
WWAN	Displays the type of wireless wide area network card installed on your computer.
Bluetooth Device	Displays the type of the Bluetooth® card installed on your computer.
Wireless Device	Displays the type of wireless card installed on your computer.
AC Adapter Type	Displays the type of the AC adapter.

## Advanced

The Advanced tab allows you to set various functions that affect the performance of the computer. The table below defines the function of each option and its default value.

Advanced		
System Configuration		
Integrated NIC	Enable or disable the power supply to the on-board network card.	Default: Enabled
SATA Mode	Change the SATA controller mode to either ATA or AHCI.	Default: AHCI
External USB ports	Enable or disable the external USB ports.	Default: Enabled
PC card or IEEE 1394 port	Enable or disable the IEEE 1394 port.	Default: Enabled
eSATA Ports	Enable or disable the eSATA port.	Default: Enabled
Module Bay	Enable or disable the module bay.	Default: Enabled
Fingerprint Reader	Enable or disable the fingerprint reader.	Default: Enabled
ExpressCard	Enable or disable the ExpressCard slot.	Default: Enabled
Camera	Enable or disable the camera.	Default: Enabled
Audio MIC Function	Enable or disable the microphone.	Default: Enabled
Hybrid Graphic	Enable or disable the hybrid graphics function.	Default: Hybrid
Performance		

EIST	Allows the clock speed of the processor to be dynamically changed by software while minimizing power draw and heat dissipation.	Default: Enabled
Execute Disable Bit	Allows increased protection against buffer overflow attacks.	Default: Enabled
Intel® Virtualization Technology	Allows a platform to run multiple operating systems and applications in independent partitions, allowing one computer to function as multiple virtual computers.	Default: Disabled
<b>Power Management</b>		
USB Wake Support	Allows USB devices to wake-up the computer from standby. This feature is enabled only when the AC adapter is connected.	Default: Enabled
Wake On LAN	Allows the computer to be remotely turned on. This feature is enabled only when the AC adapter is connected.	Default: Enabled
<b>Post Behavior</b>		
Adapter Warnings	Enables or disables adapter warnings.	Default: Enabled
Fast Boot	Allows the System Setup to skip certain tests during power on self test (POST) which decreases the amount of time needed to boot the computer.	Default: Enabled
Keyboard Click	Enable or disable the keyboard sound.	Default: Disabled
<b>Wireless</b>		
Internal Bluetooth	Enable or disable the Bluetooth module.	Default: Enabled
Internal WLAN	Enable or disable the wireless LAN module.	Default: Enabled
Internal WWAN	Enable or disable the wireless WAN module.	Default: Enabled

## Security

The Security tab displays the security status and allows you to manage the security features of the computer.

Security	
Service Tag	Displays the current service tag of the computer.
Asset Tag	Displays the asset tag.
Unlock Setup Status	Specifies whether a setup password has been assigned.
Admin Password Status	Specifies whether an admin password has been assigned.
Admin Password	Allows you to set an admin password.
System Password Status	Specifies whether a system password has been assigned.
System Password	Allows you to set a system password.
Password on Boot	Enable or disable authentication every time your computer boots.
Password Bypass	Allows you to bypass the system and hard drive passwords when your computer restarts.  However, you must enter the passwords if you are turning the computer on from the shutdown state.
Password Change	Enable or disable the password change feature.
Computrace	Enable or disable the Computrace feature on your computer.
HDD Password Configuration	Allows you to set a password on the computer's internal hard drive (HDD). The hard drive password is enabled even when the hard drive is installed on another computer.

## Boot

The Boot tab allows you to change the boot sequence.

## Exit

This section allows you to save, discard, and load default settings before exiting from System Setup.

---

[Back to Contents Page](#)

[Back to Contents Page](#)

## Bluetooth Card

Dell™ Vostro™ 3700 Service Manual

**⚠ WARNING:** Before working inside your computer, read the safety information that shipped with your computer. For additional safety best practices information, see the Regulatory Compliance Homepage at [www.dell.com/regulatory\\_compliance](http://www.dell.com/regulatory_compliance).

---

### Removing the Bluetooth Card



1. Follow the procedures in [Before Working Inside Your Computer](#).
2. Remove the [battery](#).
3. Remove the [base cover](#).
4. Remove the [hard drive](#).
5. Remove the [optical drive](#).
6. Remove the [keyboard](#).
7. Remove the [palm rest](#).
8. Remove the [audio board](#).
9. Lift the Bluetooth® card up and away from the audio board.

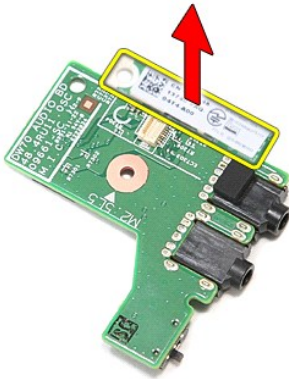

### Replacing the Bluetooth Card

To replace the Bluetooth card, perform the above steps in reverse order.

---

[Back to Contents Page](#)

[Back to Contents Page](#)

## Camera

Dell™ Vostro™ 3700 Service Manual

**WARNING:** Before working inside your computer, read the safety information that shipped with your computer. For additional safety best practices information, see the Regulatory Compliance Homepage at [www.dell.com/regulatory\\_compliance](http://www.dell.com/regulatory_compliance).

---

### Removing the Camera



1. Follow the procedures in [Before Working Inside Your Computer](#).
2. Remove the [battery](#).
3. Remove the [base cover](#).
4. Remove the [hard drive](#).
5. Remove the [optical drive](#).
6. Remove the [wireless local area network \(WLAN\) card](#).
7. Remove the [keyboard](#).
8. Remove the [palm rest](#).
9. Remove the [display assembly](#).
10. Remove the [display bezel](#).
11. Remove the tape that secures the camera to the display assembly.

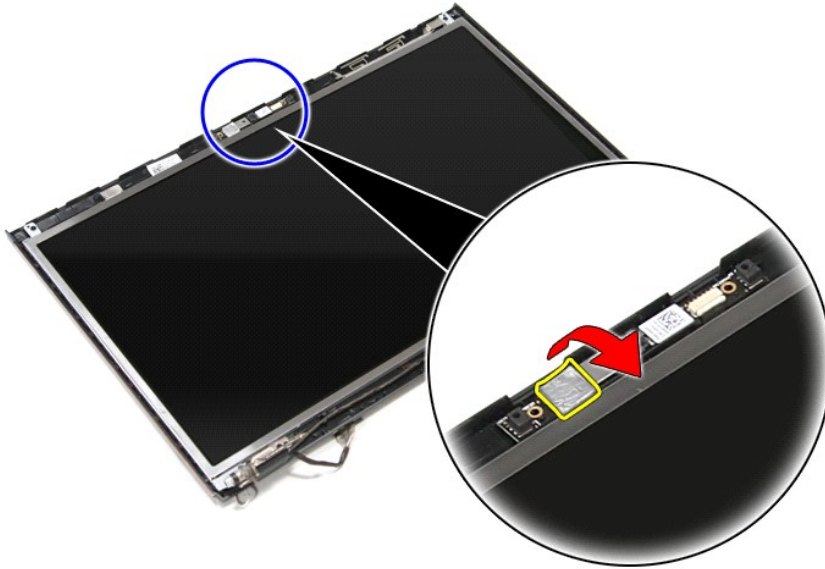

12. Disconnect the camera cable from the display assembly.

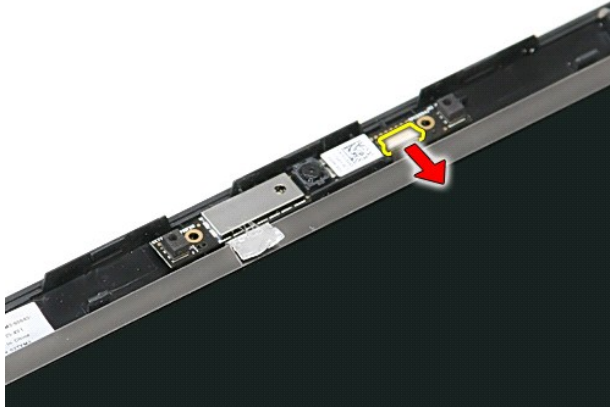

13. Lift the camera up and away from the computer.

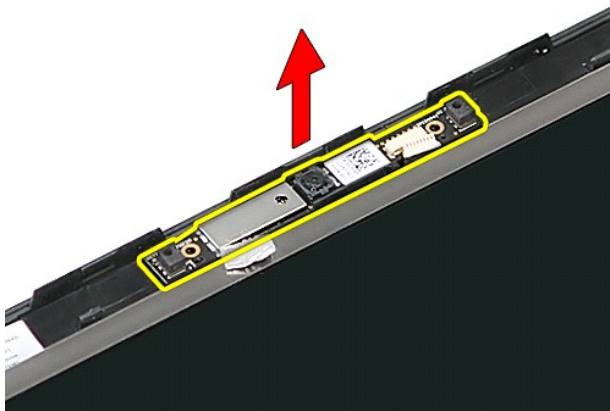

## Replacing the Camera

To replace the camera, perform the above steps in reverse order.

---

[Back to Contents Page](#)

[Back to Contents Page](#)

## Coin-Cell Battery

Dell™ Vostro™ 3700 Service Manual

**⚠ WARNING:** Before working inside your computer, read the safety information that shipped with your computer. For additional safety best practices information, see the Regulatory Compliance Homepage at [www.dell.com/regulatory\\_compliance](http://www.dell.com/regulatory_compliance).

---

### Removing the Coin-Cell Battery



1. Follow the procedures in [Before Working Inside Your Computer](#).
2. Remove the [battery](#).
3. Remove the [base cover](#).
4. Disconnect the coin-cell battery cable from the system board.

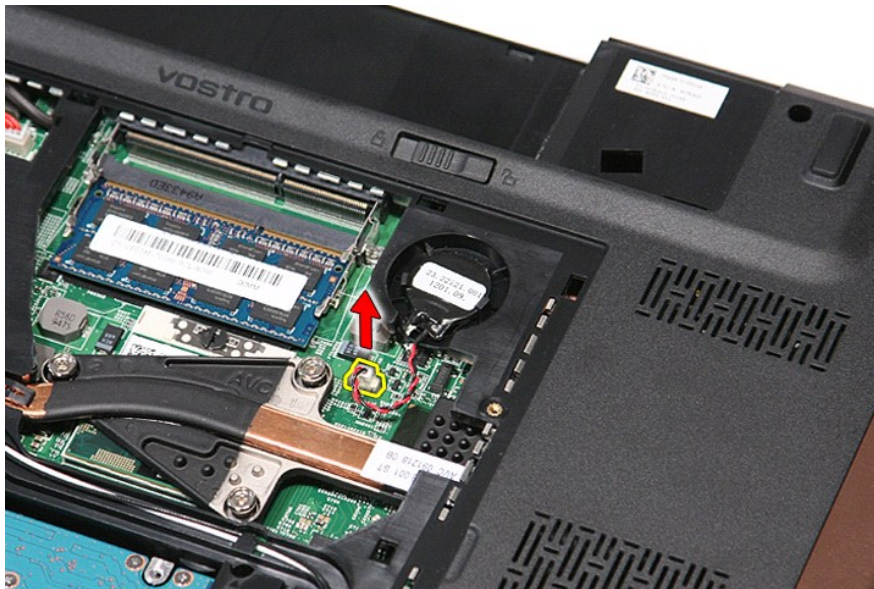

5. Gently pry the tabs that secure the coin-cell battery to the system board away from the coin-cell battery.



6. Lift up the coin-cell battery and remove it from the computer.

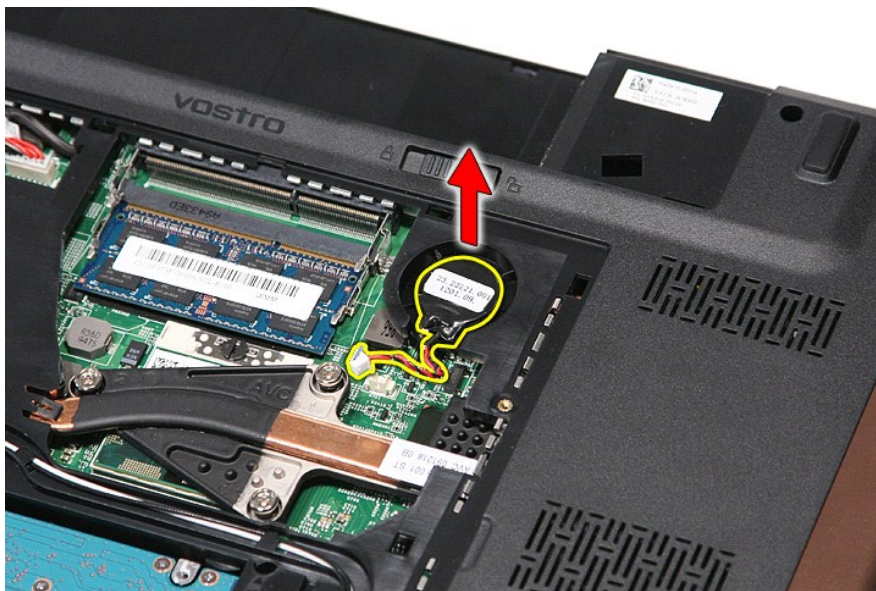

## Replacing the Coin-Cell Battery

To replace the coin-cell battery, perform the above steps in reverse order.

[Back to Contents Page](#)







## Diagnostics

### Dell™ Vostro™ 3700 Service Manual

- [Device Status Lights](#)
- [Battery Status Lights](#)
- [Battery Charge and Health](#)
- [Keyboard Status Lights](#)
- [LED Error Codes](#)

## Device Status Lights

-  Turns on when you turn on the computer and blinks when the computer is in a power management mode.
-  Turns on when the computer reads or writes data.
-  Turns on steadily or blinks to indicate battery charge status.
-  Turns on when wireless networking is enabled.
-  Turns on when a card with Bluetooth® wireless technology is enabled. To turn off only the Bluetooth wireless technology function, right-click the icon in the system tray and select **Disable Bluetooth Radio**.

## Battery Status Lights

If the computer is connected to an electrical outlet, the battery light operates as follows:

- 1 **Alternately blinking amber light and blue light** — An unauthenticated or unsupported non-Dell AC adapter is attached to your laptop.
- 1 **Alternately blinking amber light with steady blue light** — Temporary battery failure with AC adapter present.
- 1 **Constantly blinking amber light** — Fatal battery failure with AC adapter present.
- 1 **Light off** — Battery in full charge mode with AC adapter present.
- 1 **Blue light on** — Battery in charge mode with AC adapter present.



## Battery Charge and Health

To check the battery charge, press and release the status button on the battery charge gauge to illuminate the charge-level lights. Each light represents approximately 20 percent of the total battery charge. For example, if four lights are on, the battery has 80 percent of its charge remaining. If no lights appear, the battery has no charge.

To check battery health using the charge gauge, press and hold the status button on the battery charge gauge for at least 3 seconds. If no lights appear, the battery is in good condition and more than 80 percent of its original charge capacity remains. Each light represents incremental degradation. If five lights appear, less than 60 percent of the charge capacity remains, and you should consider replacing the battery.



## Keyboard Status Lights

The green lights located above the keyboard indicate the following:

-  Turns on when the numeric keypad is enabled.
-  Turns on when the Caps Lock function is enabled.
-  Turns on when the Scroll Lock function is enabled.

## LED Error Codes

The following table shows the possible LED codes that may display when your computer is unable to complete a power on self test.

Appearance	Description	Next Step
<b>ON-FLASH-FLASH</b> 	No SODIMMs are installed	<ol style="list-style-type: none"><li>1. Install supported memory modules.</li><li>2. If memory is already present, reseat the module(s) one at a time in each slot.</li><li>3. Try known good memory from another computer or replace the memory.</li><li>4. Replace the system board.</li></ol>
<b>FLASH-ON-ON</b> 	System board error	<ol style="list-style-type: none"><li>1. Reseat the processor.</li><li>2. Replace the system board.</li><li>3. Replace the processor.</li></ol>

<p style="text-align: center;"><b>FLASH-ON-FLASH</b></p> 	Display panel error	<ol style="list-style-type: none"> <li>1. Reseat the display cable.</li> <li>2. Replace the display panel.</li> <li>3. Replace the video card/system board.</li> </ol>
<p style="text-align: center;"><b>OFF-FLASH-OFF</b></p> 	Memory compatibility error	<ol style="list-style-type: none"> <li>1. Install compatible memory modules.</li> <li>2. If two modules are installed remove one and test. Try the other module in the same slot and test. Test the other slot with both modules.</li> <li>3. Replace the memory.</li> <li>4. Replace the system board.</li> </ol>
<p style="text-align: center;"><b>ON-FLASH-ON</b></p> 	Memory is detected but has errors	<ol style="list-style-type: none"> <li>1. Reseat the memory.</li> <li>2. If two modules are installed remove one and test. Try the other module in the same slot and test. Test the other slot with both modules.</li> <li>3. Replace the memory.</li> <li>4. Replace the system board.</li> </ol>
<p style="text-align: center;"><b>OFF-FLASH-FLASH</b></p> 	Modem error	<ol style="list-style-type: none"> <li>1. Reseat the modem.</li> <li>2. Replace the modem.</li> <li>3. Replace the system board.</li> </ol>
<p style="text-align: center;"><b>FLASH-FLASH-FLASH</b></p> 	System board error	<ol style="list-style-type: none"> <li>1. Replace the system board.</li> </ol>
<p style="text-align: center;"><b>FLASH-FLASH-OFF</b></p> 	Option ROM error	<ol style="list-style-type: none"> <li>1. Reseat the device.</li> <li>2. Replace the device.</li> <li>3. Replace the system board.</li> </ol>
<p style="text-align: center;"><b>OFF-ON-OFF</b></p> 	Storage device error	<ol style="list-style-type: none"> <li>1. Reseat the hard drive and optical drive.</li> <li>2. Test the computer with just the hard drive and just the optical drive.</li> <li>3. Replace the device that is causing the failure.</li> <li>4. Replace the system board.</li> </ol>
<p style="text-align: center;"><b>FLASH-FLASH-ON</b></p> 	Video card error	<ol style="list-style-type: none"> <li>1. Replace the system board.</li> </ol>

[Back to Contents Page](#)

## Display Assembly

Dell™ Vostro™ 3700 Service Manual

**WARNING:** Before working inside your computer, read the safety information that shipped with your computer. For additional safety best practices information, see the Regulatory Compliance Homepage at [www.dell.com/regulatory\\_compliance](http://www.dell.com/regulatory_compliance).

### Removing the Display Assembly



1. Follow the procedures in [Before Working Inside Your Computer](#).
2. Remove the [battery](#).
3. Remove the [base cover](#).
4. Remove the [wireless local area network \(WLAN\) card](#).
5. Remove the [hard drive](#).
6. Remove the [optical drive](#).
7. Remove the [keyboard](#).
8. Remove the [palm rest](#).
9. Flip the computer over and release the antenna cables from their routing guides on the computer.

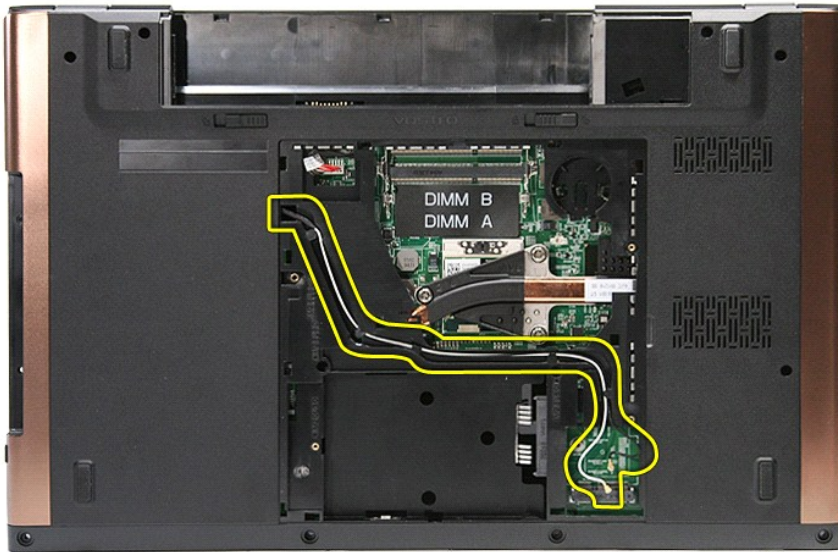

10. With the right side of the computer facing up, disconnect the display cable from its connector on the system board.

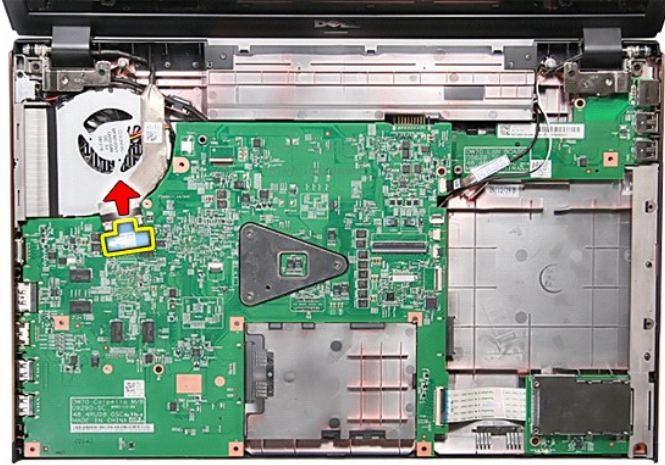

11. Disconnect the antenna cables from their connectors on the system board.

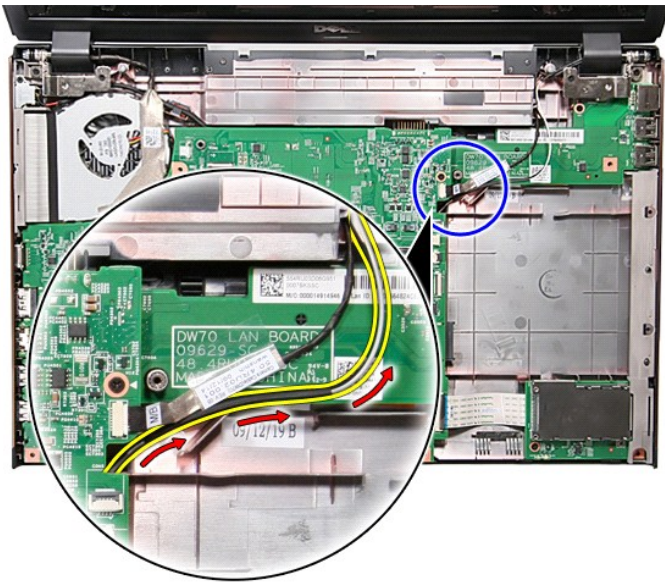

12. Disconnect the camera cable from its connector on the system board.

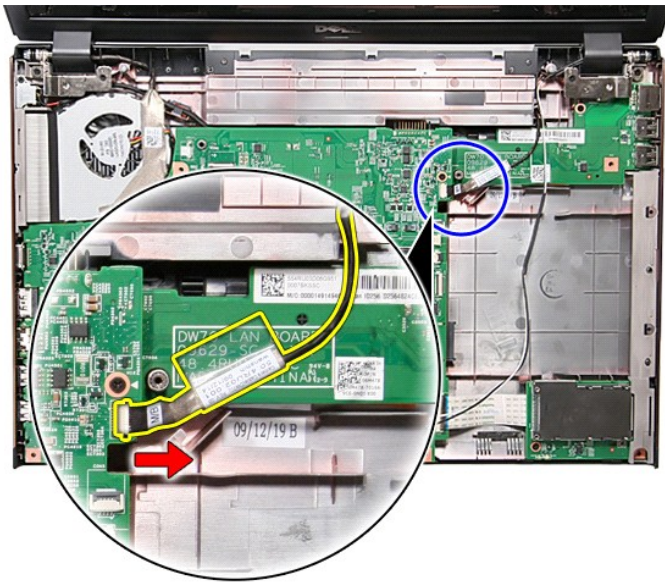

13. Remove the screws that secure the display assembly to the computer.

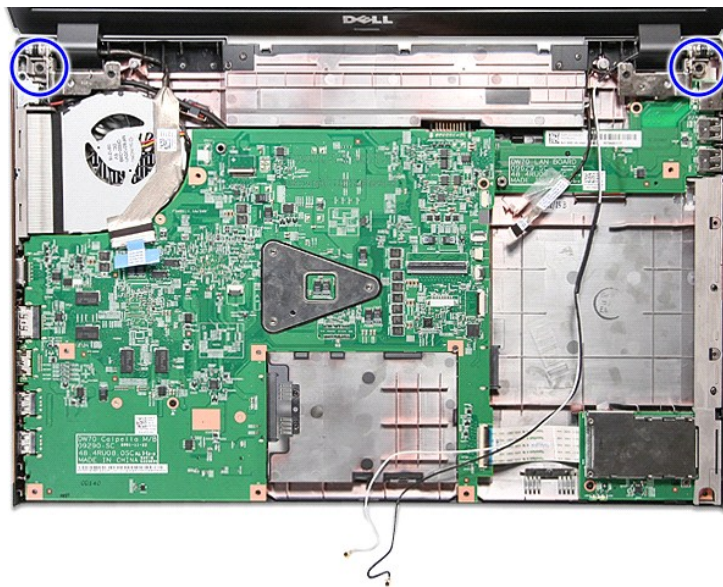

14. Lift the display assembly up and away from the computer.

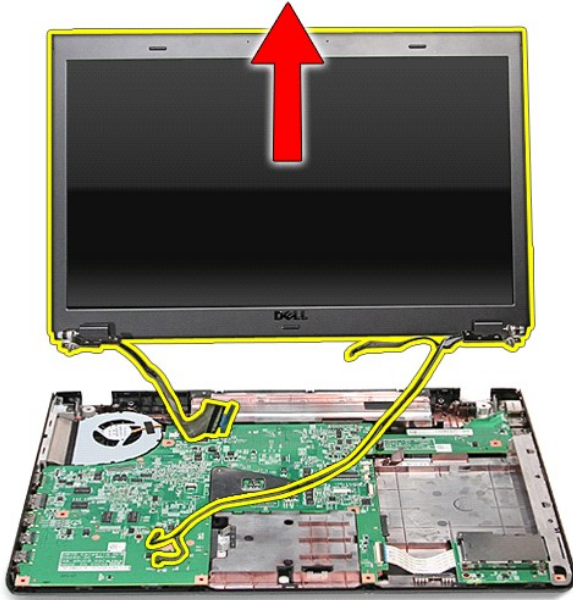

## Replacing the Display Assembly

To replace the display panel, perform the above steps in reverse order.

---

[Back to Contents Page](#)

[Back to Contents Page](#)

## ExpressCard Cage

### Dell™ Vostro™ 3700 Service Manual

**WARNING:** Before working inside your computer, read the safety information that shipped with your computer. For additional safety best practices information, see the Regulatory Compliance Homepage at [www.dell.com/regulatory\\_compliance](http://www.dell.com/regulatory_compliance).

---

## Removing the ExpressCard Cage



1. Follow the procedures in [Before Working Inside Your Computer](#).
2. Remove the [battery](#).
3. Remove the [base cover](#).
4. Remove the [hard drive](#).
5. Remove the [optical drive](#).
6. Remove the [keyboard](#).
7. Remove the [palm rest](#).
8. Remove the [ExpressCard](#), if applicable.
9. Remove the screw that secures the ExpressCard cage to the computer.



10. Open the clip that secures the ExpressCard cage cable to its connector on the system board.

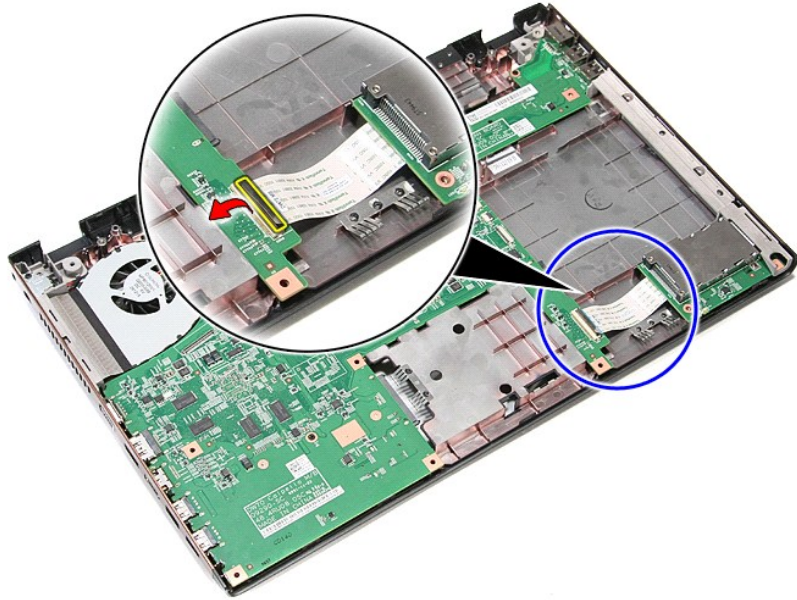

11. Disconnect the ExpressCard cage cable from its connector on the system board.

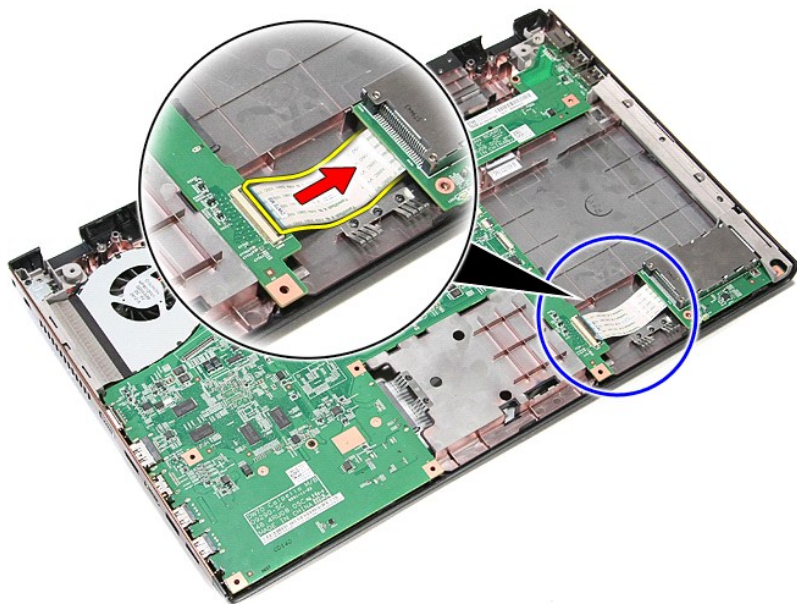

12. Lift the ExpressCard cage up and away from the computer.



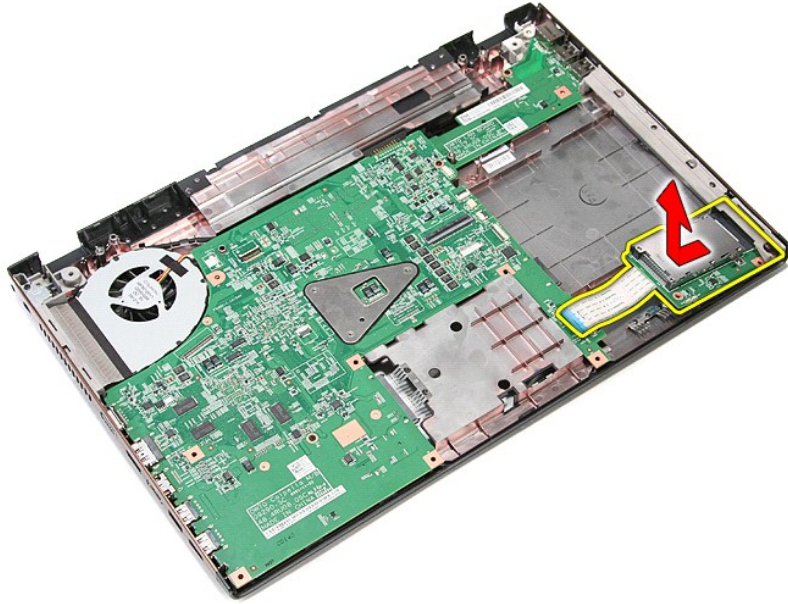

## Replacing the ExpressCard Cage

To replace the ExpressCard cage, perform the above steps in reverse order.

---

[Back to Contents Page](#)

[Back to Contents Page](#)

## ExpressCard

Dell™ Vostro™ 3700 Service Manual

**⚠ WARNING:** Before working inside your computer, read the safety information that shipped with your computer. For additional safety best practices information, see the Regulatory Compliance Homepage at [www.dell.com/regulatory\\_compliance](http://www.dell.com/regulatory_compliance).

---

### Removing the ExpressCard



1. Follow the procedures in [Before Working Inside Your Computer](#).
2. Press in on the ExpressCard to release it from the computer.

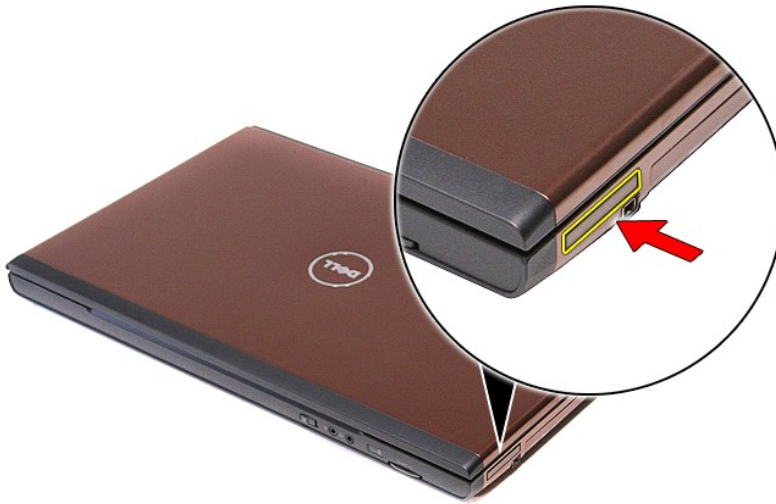

3. Slide the ExpressCard out of the computer.



## Replacing the ExpressCard

To replace the ExpressCard, perform the above steps in reverse order.

---

[Back to Contents Page](#)

[Back to Contents Page](#)

## Hard Drive

Dell™ Vostro™ 3700 Service Manual

**WARNING:** Before working inside your computer, read the safety information that shipped with your computer. For additional safety best practices information, see the Regulatory Compliance Homepage at [www.dell.com/regulatory\\_compliance](http://www.dell.com/regulatory_compliance).

---

### Removing the Hard Drive



1. Follow the procedures in [Before Working Inside Your Computer](#).
2. Remove the [battery](#).
3. Remove the [base cover](#).
4. Remove the screw that secures the hard-drive assembly to the computer.



5. Slide the hard-drive assembly towards the center of the computer and lift it up and away from the computer.

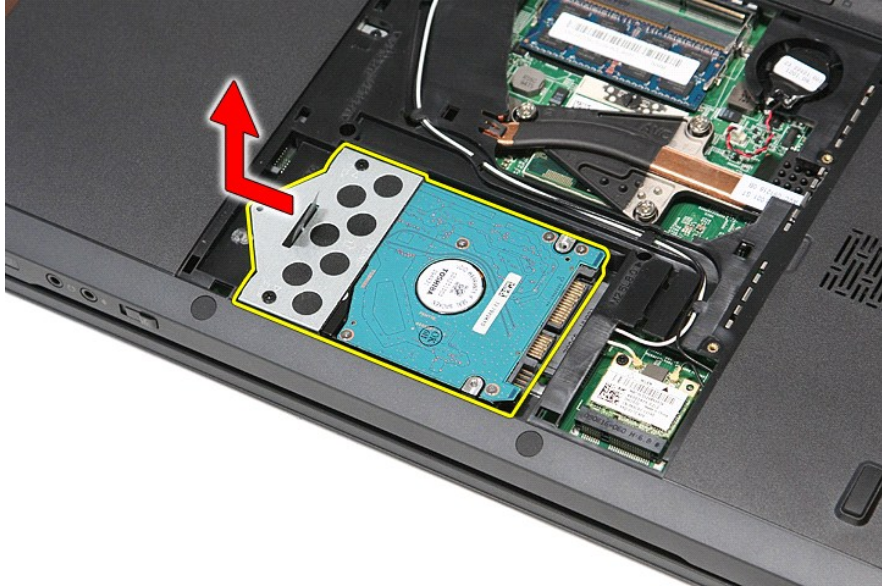

6. Remove the screws that secure the hard-drive bracket to the hard drive.



7. Lift up the hard-drive bracket and remove it from the hard-drive assembly.

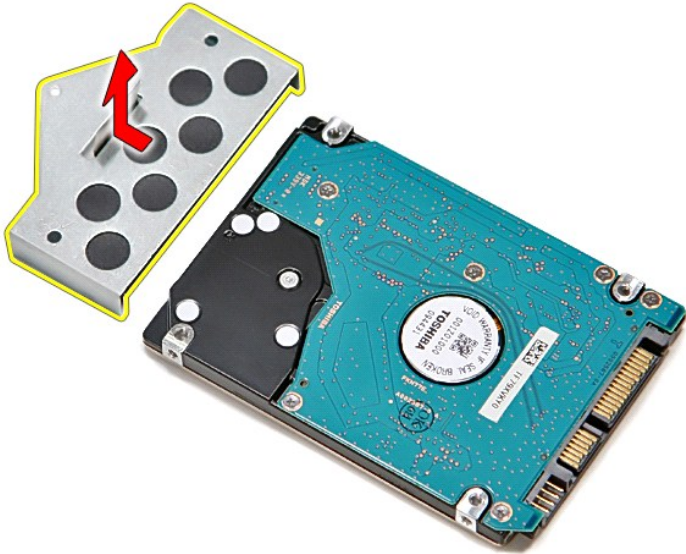

# Replacing the Hard Drive

To replace the hard drive, perform the above steps in reverse order.



[Back to Contents Page](#)

[Back to Contents Page](#)

## Heat Sink and Fan Assembly

Dell™ Vostro™ 3700 Service Manual

**⚠ WARNING:** Before working inside your computer, read the safety information that shipped with your computer. For additional safety best practices information, see the Regulatory Compliance Homepage at [www.dell.com/regulatory\\_compliance](http://www.dell.com/regulatory_compliance).

### Removing the Heat Sink and Fan Assembly



1. Follow the procedures in [Before Working Inside Your Computer](#).
2. Remove the [battery](#).
3. Remove the [base cover](#).
4. Remove the [coin-cell battery](#).
5. Remove the [hard drive](#).
6. Remove the [optical drive](#).
7. Remove the [wireless local area network \(WLAN\) card](#).
8. Remove the [keyboard](#).
9. Remove the [palm rest](#).
10. Remove the [display assembly](#).
11. Remove the [ExpressCard cage](#).
12. Remove the [system board](#).
13. Disconnect the fan cable from its connector on the system board.

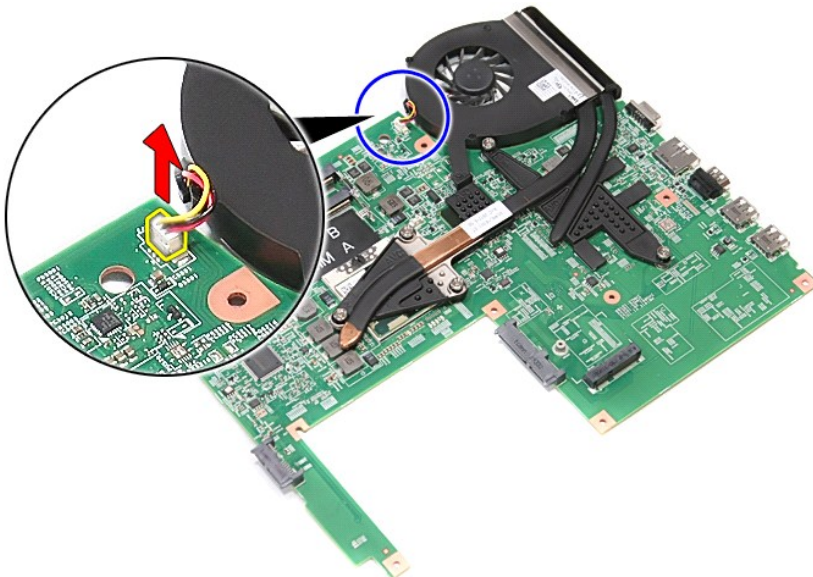

14. Loosen the screws that secure the heat sink and fan assembly to the system board.

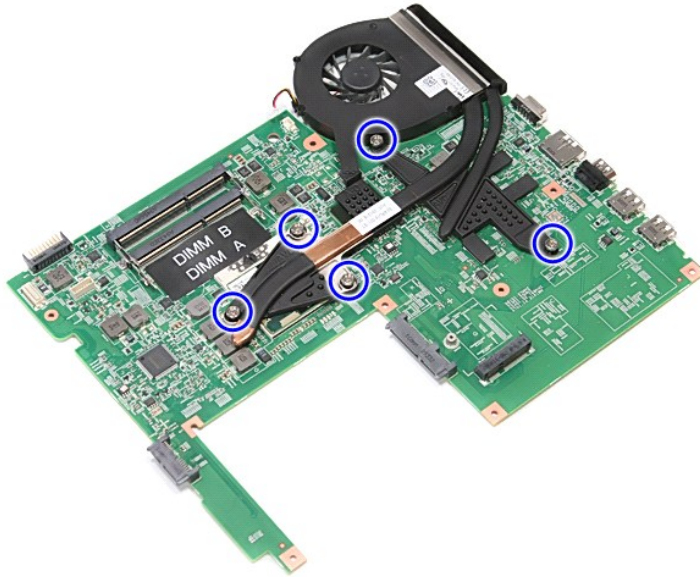

15. Lift the heat sink and fan assembly up and away from the system board.

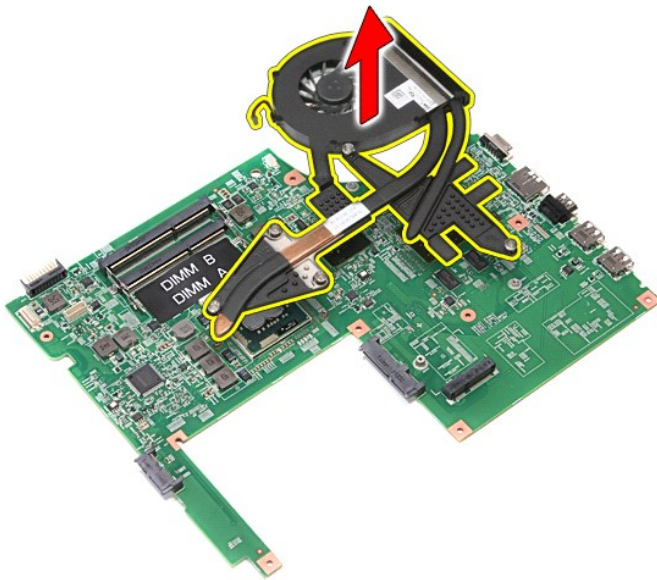

## Replacing the Heat Sink and Fan Assembly

To replace the heat sink and fan assembly, perform the above steps in reverse order.

---

[Back to Contents Page](#)



[Back to Contents Page](#)

## IO Board

Dell™ Vostro™ 3700 Service Manual

**WARNING:** Before working inside your computer, read the safety information that shipped with your computer. For additional safety best practices information, see the Regulatory Compliance Homepage at [www.dell.com/regulatory\\_compliance](http://www.dell.com/regulatory_compliance).

### Removing the IO Board



1. Follow the procedures in [Before Working Inside Your Computer](#).
2. Remove the [battery](#).
3. Remove the [base cover](#).
4. Remove the [coin-cell battery](#).
5. Remove the [hard drive](#).
6. Remove the [optical drive](#).
7. Remove the [wireless local area network \(WLAN\) card](#).
8. Remove the [keyboard](#).
9. Remove the [palm rest](#).
10. Remove the [display assembly](#).
11. Remove the [ExpressCard cage](#).
12. Remove the [system board](#).
13. Remove the screw that secures the IO board to the computer.

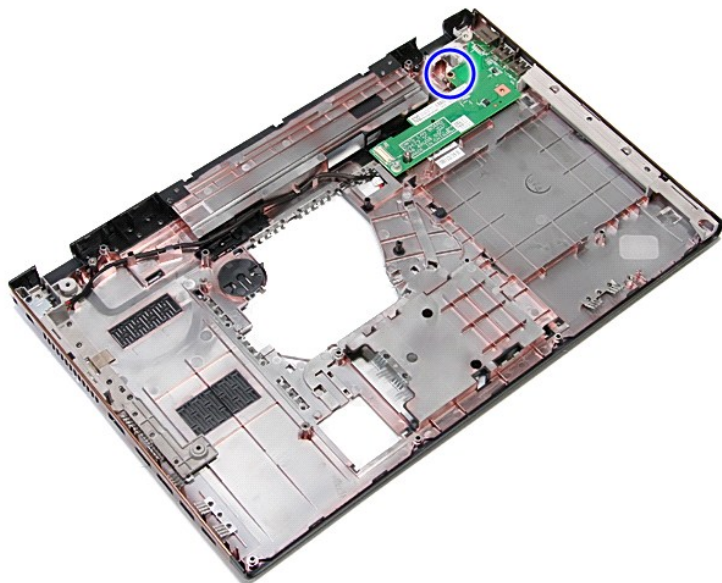

14. Lift the IO board and turn it over.

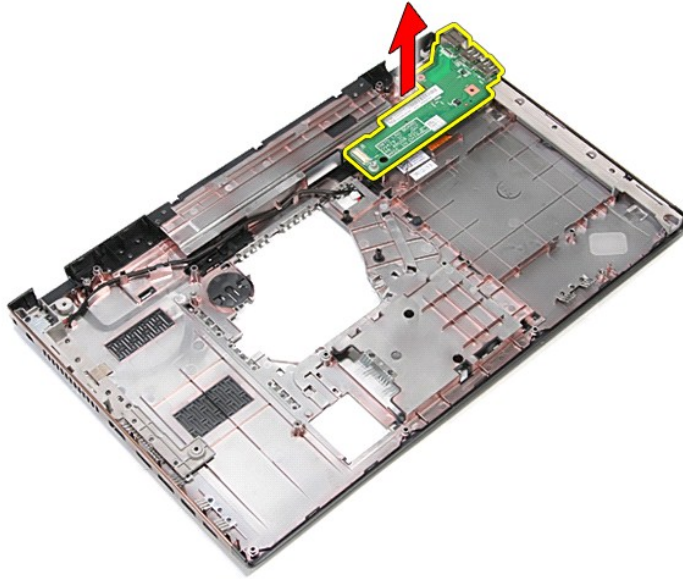

## Replacing the IO Board

To replace the IO board, perform the above steps in reverse order.

---

[Back to Contents Page](#)

[Back to Contents Page](#)

## Keyboard

Dell™ Vostro™ 3700 Service Manual

**WARNING:** Before working inside your computer, read the safety information that shipped with your computer. For additional safety best practices information, see the Regulatory Compliance Homepage at [www.dell.com/regulatory\\_compliance](http://www.dell.com/regulatory_compliance).

---

### Removing the Keyboard



1. Follow the procedures in [Before Working Inside Your Computer](#).
2. Remove the [battery](#).
3. Flip the computer over with the right side facing up.
4. Using a small plastic scribe, press in on the release latches and pry the keyboard to release it.



5. Lift the keyboard and turn it over.



6. Carefully open the clip to release the keyboard cable.

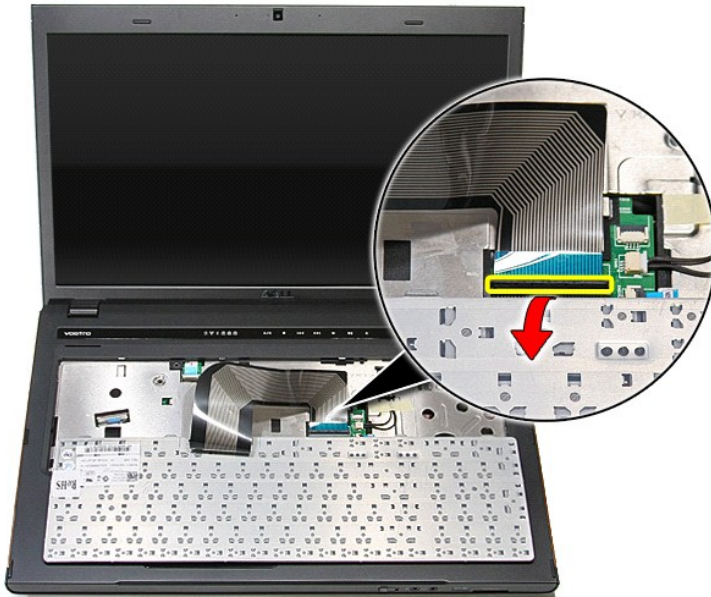

7. Disconnect the keyboard cable from its connector on the system board and remove the keyboard from the computer.

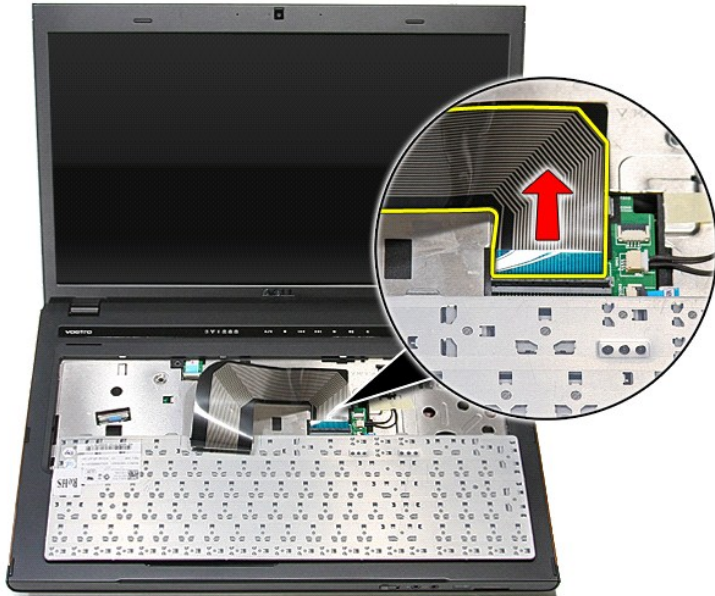

## Replacing the Keyboard

To replace the keyboard, perform the above steps in reverse order.

---

[Back to Contents Page](#)

[Back to Contents Page](#)

## Display Bezel

Dell™ Vostro™ 3700 Service Manual

**WARNING:** Before working inside your computer, read the safety information that shipped with your computer. For additional safety best practices information, see the Regulatory Compliance Homepage at [www.dell.com/regulatory\\_compliance](http://www.dell.com/regulatory_compliance).

---

### Removing the Display Bezel



1. Follow the procedures in [Before Working Inside Your Computer](#).
2. Remove the [battery](#).
3. Remove the [base cover](#).
4. Remove the [hard drive](#).
5. Remove the [optical drive](#).
6. Remove the [wireless local area network \(WLAN\) card](#).
7. Remove the [keyboard](#).
8. Remove the [palm rest](#).
9. Remove the [display assembly](#).
10. Using a plastic scribe, gently pry under the display bezel to release it from the display assembly.



11. Lift the display bezel and remove it from the display assembly.

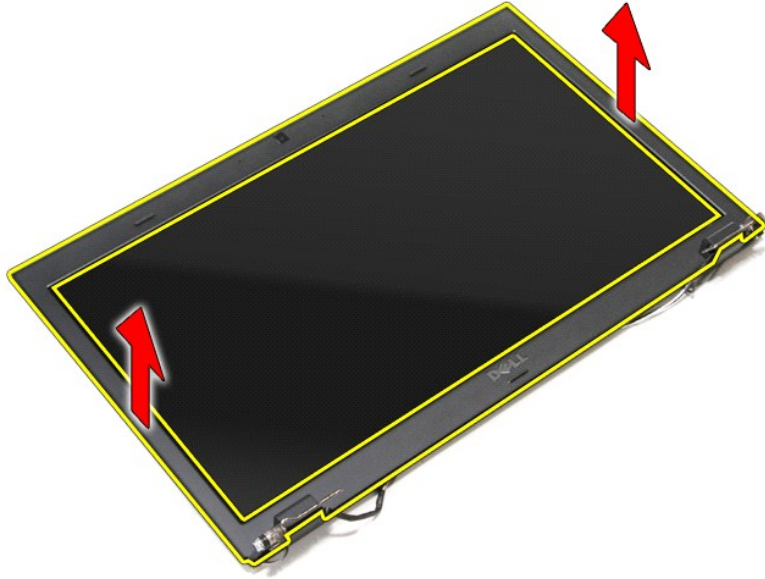

### Replacing the Display Bezel

To replace the display bezel, perform the above steps in reverse order.

---

[Back to Contents Page](#)

[Back to Contents Page](#)

## Display Hinges

Dell™ Vostro™ 3700 Service Manual

**⚠ WARNING:** Before working inside your computer, read the safety information that shipped with your computer. For additional safety best practices information, see the Regulatory Compliance Homepage at [www.dell.com/regulatory\\_compliance](http://www.dell.com/regulatory_compliance).

---

### Removing the Display Hinges



1. Follow the procedures in [Before Working Inside Your Computer](#).
2. Remove the [battery](#).
3. Remove the [base cover](#).
4. Remove the [hard drive](#).
5. Remove the [optical drive](#).
6. Remove the [wireless local area network \(WLAN\) card](#).
7. Remove the [keyboard](#).
8. Remove the [palm rest](#).
9. Remove the [display assembly](#).
10. Remove the [display panel](#).
11. Remove the screws that secure the display hinges to the display cover.



12. Remove the display hinges from the display cover.



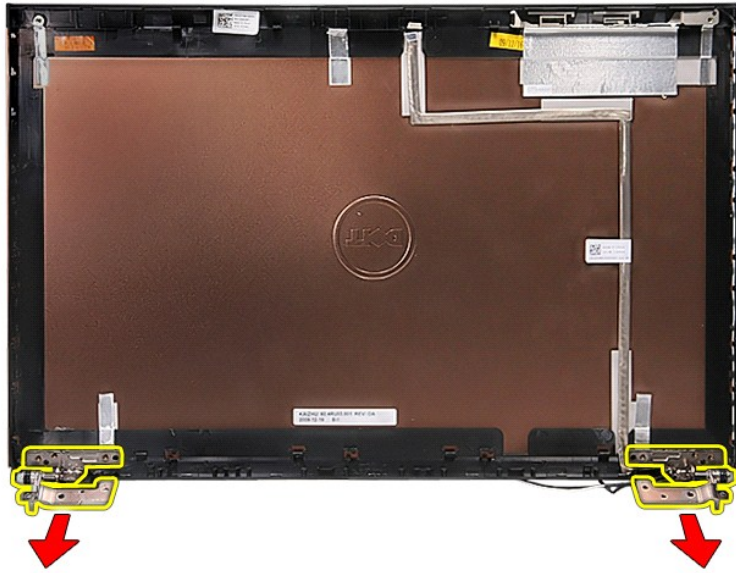

### Replacing the Display Hinges

To replace the display hinges, perform the above steps in reverse order.

---

[Back to Contents Page](#)

[Back to Contents Page](#)

## Display Panel

Dell™ Vostro™ 3700 Service Manual

**WARNING:** Before working inside your computer, read the safety information that shipped with your computer. For additional safety best practices information, see the Regulatory Compliance Homepage at [www.dell.com/regulatory\\_compliance](http://www.dell.com/regulatory_compliance).

---

### Removing the Display Panel

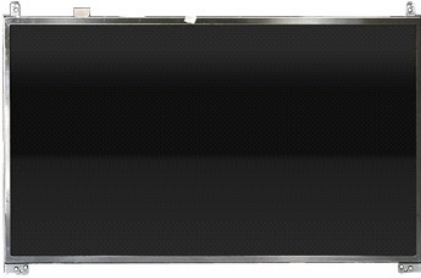

1. Follow the procedures in [Before Working Inside Your Computer](#).
2. Remove the [battery](#).
3. Remove the [base cover](#).
4. Remove the [hard drive](#).
5. Remove the [optical drive](#).
6. Remove the [wireless wide area network \(WLAN\) card](#).
7. Remove the [keyboard](#).
8. Remove the [palm rest](#).
9. Remove the [display assembly](#).
10. Remove the [display bezel](#).
11. Remove the screws that secure the display panel to the display assembly.

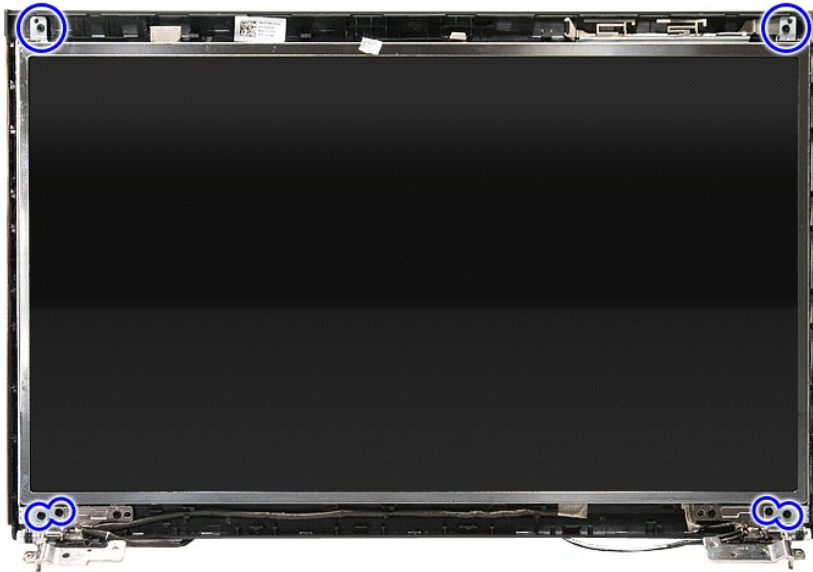

12. Release the Display cable from the hinge to the left of the display panel.

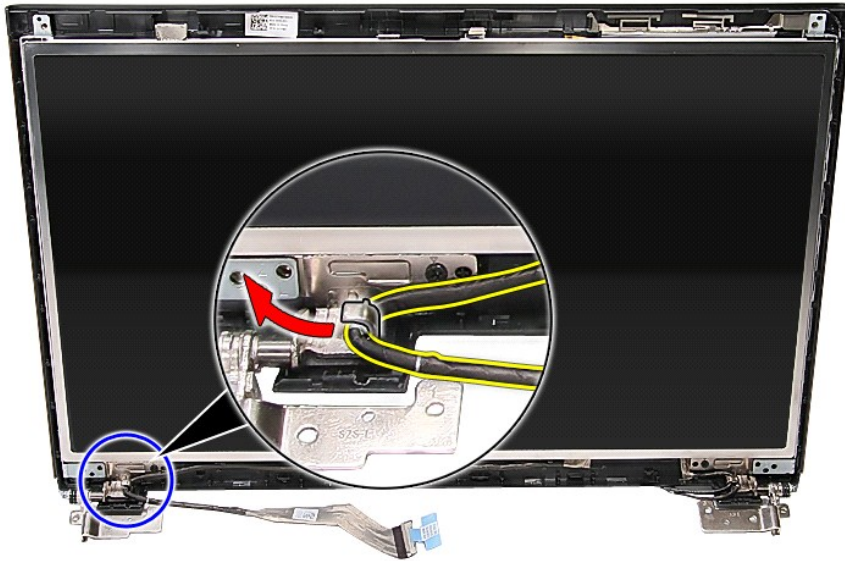

13. Carefully lift the display panel from the display assembly.

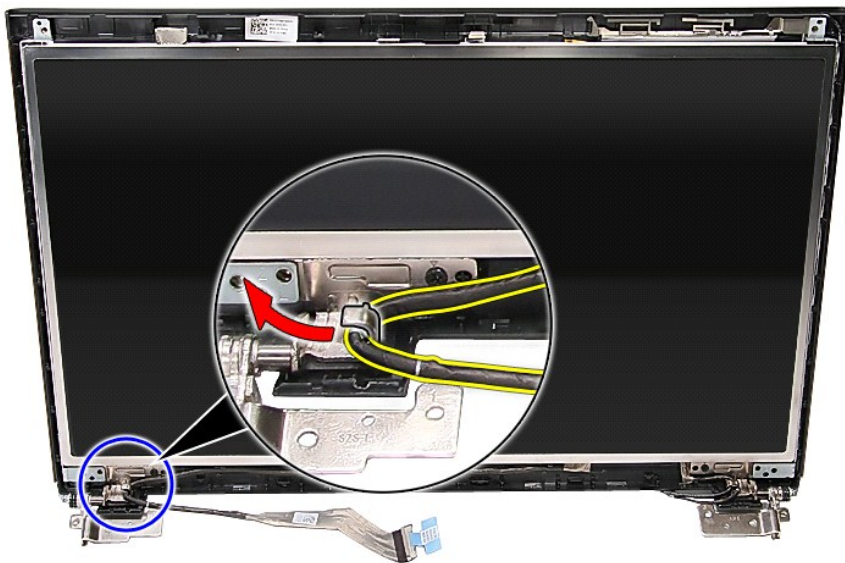

14. Lift the display panel along with the hinges up and away from the display assembly.

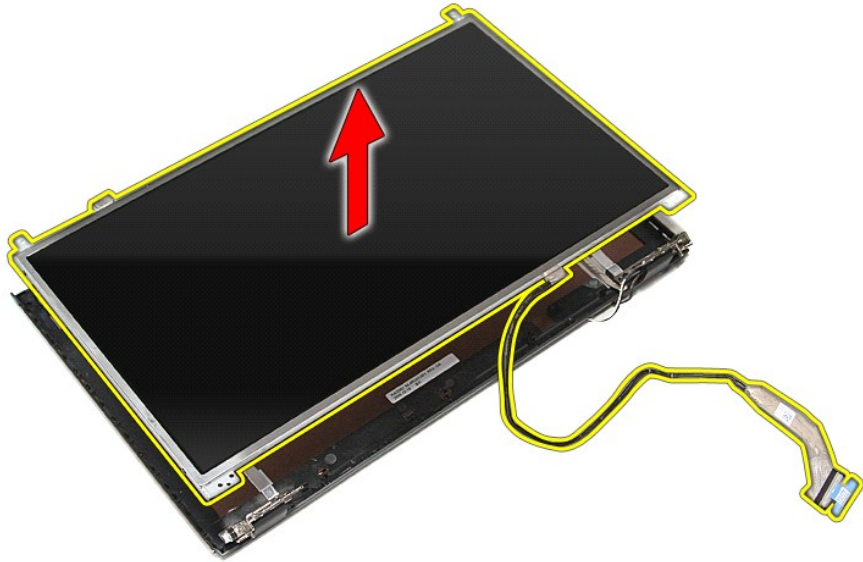

15. Remove the tape that secures the display cable to the display panel.

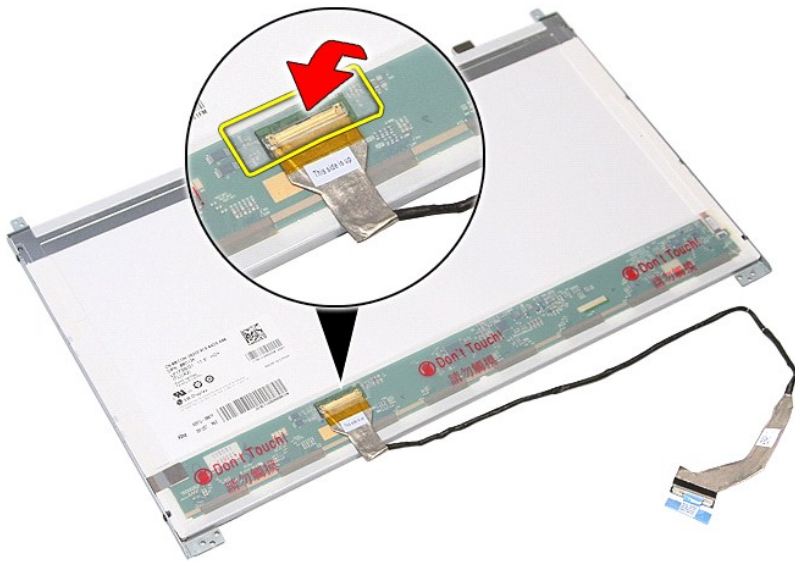

16. Disconnect the display cable from its connector on the display panel.

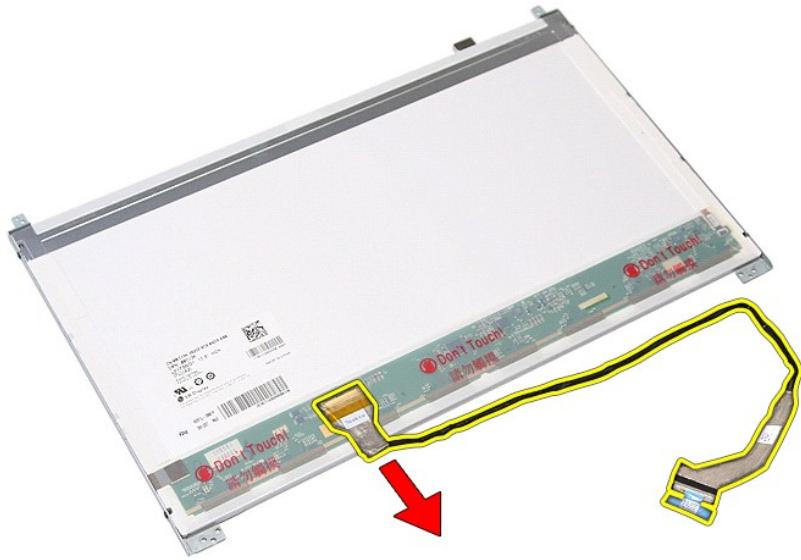

17. Remove the screws that secure the display brackets to the display panel and remove the brackets from the display panel.



## Replacing the Display Panel

To replace the display panel, perform the above steps in reverse order.

---

[Back to Contents Page](#)

[Back to Contents Page](#)

## Memory

Dell™ Vostro™ 3700 Service Manual

**WARNING:** Before working inside your computer, read the safety information that shipped with your computer. For additional safety best practices information, see the Regulatory Compliance Homepage at [www.dell.com/regulatory\\_compliance](http://www.dell.com/regulatory_compliance).

### Removing the Memory Module(s)



1. Follow the procedures in [Before Working Inside Your Computer](#).
2. Remove the [battery](#).
3. Remove the [base cover](#).
4. Push apart the memory retention clips to release the memory module.



5. Remove the memory module from its connector on the system board.



## Replacing the Memory Module(s)

To replace the memory module(s), perform the above steps in reverse order.

---

[Back to Contents Page](#)

[Back to Contents Page](#)

## Memory Card

Dell™ Vostro™ 3700 Service Manual

**⚠ WARNING:** Before working inside your computer, read the safety information that shipped with your computer. For additional safety best practices information, see the Regulatory Compliance Homepage at [www.dell.com/regulatory\\_compliance](http://www.dell.com/regulatory_compliance).

---

### Removing the Memory Card



1. Follow the procedures in [Before Working Inside Your Computer](#).
2. Press in on the memory card to release it from the computer.



3. Slide the memory card out and remove from the computer.

### Replacing the Memory Card

To replace the memory card, perform the above steps in reverse order.

---

[Back to Contents Page](#)



[Back to Contents Page](#)

## Optical Drive

Dell™ Vostro™ 3700 Service Manual

**WARNING:** Before working inside your computer, read the safety information that shipped with your computer. For additional safety best practices information, see the Regulatory Compliance Homepage at [www.dell.com/regulatory\\_compliance](http://www.dell.com/regulatory_compliance).

---

### Removing the Optical Drive



1. Follow the procedures in [Before Working Inside Your Computer](#).
2. Remove the [battery](#).
3. Remove the [base cover](#).
4. Remove the screw that secures the optical drive to the computer.



5. Using a screwdriver carefully, gently pry the optical drive and remove it from the computer.

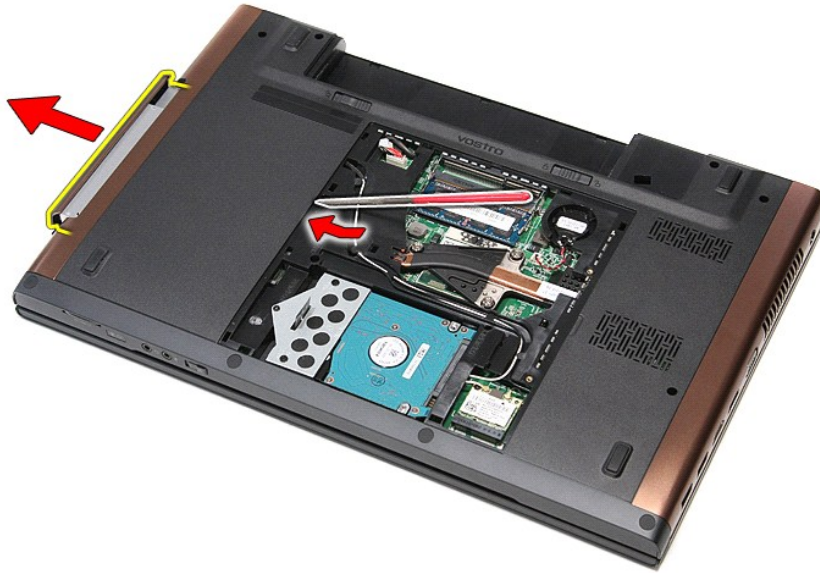

### Replacing the Optical Drive

To replace the optical drive, perform the above steps in reverse order.

---

[Back to Contents Page](#)

[Back to Contents Page](#)

## Palm Rest

Dell™ Vostro™ 3700 Service Manual

**WARNING:** Before working inside your computer, read the safety information that shipped with your computer. For additional safety best practices information, see the Regulatory Compliance Homepage at [www.dell.com/regulatory\\_compliance](http://www.dell.com/regulatory_compliance).

### Removing the Palm Rest

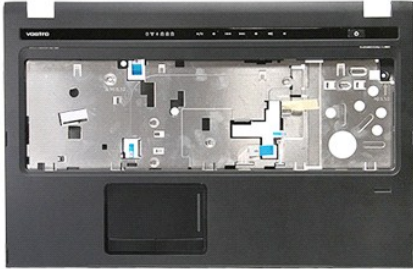

1. Follow the procedures in [Before Working Inside Your Computer](#).
2. Remove the [battery](#).
3. Remove the [base cover](#).
4. Remove the [hard drive](#).
5. Remove the [optical drive](#).
6. Remove the [keyboard](#).
7. Remove the rubber feet at the bottom of the computer.



8. Remove the screws that secure the palm rest to the bottom of the computer.

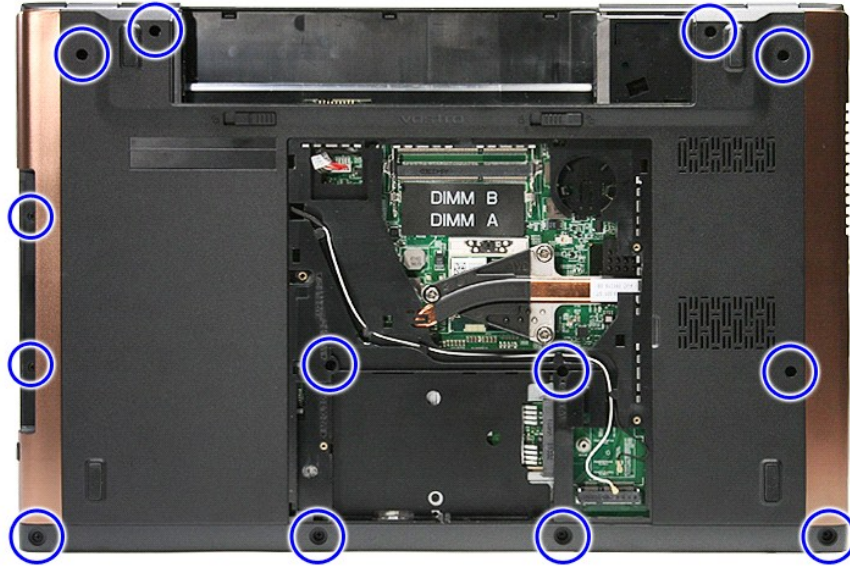

9. Flip the computer over with the right side facing up.
10. Disconnect the speaker cable from its connector on the system board.



11. Open the clip that secures the fingerprint data cable to its connector on the system board.

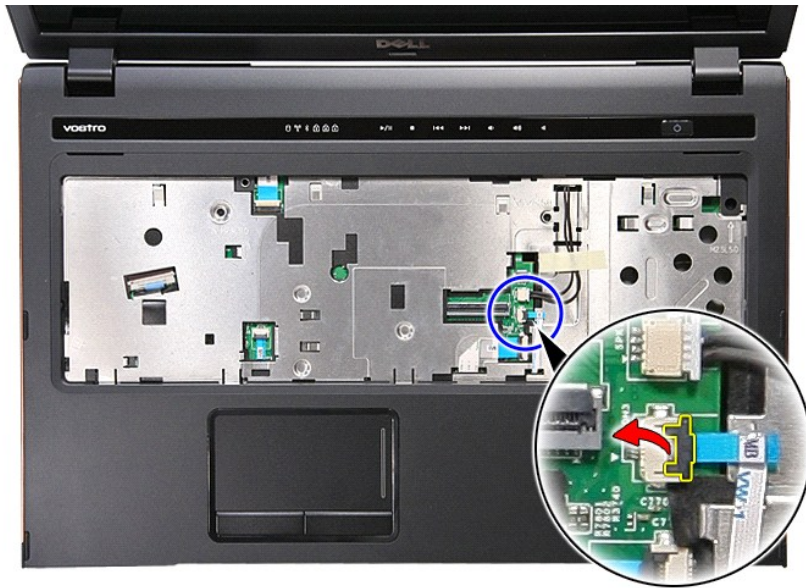

12. Disconnect the fingerprint data cable from its connector on the system board.



13. Open the clip that secures the audio cable to its connector on the system board.

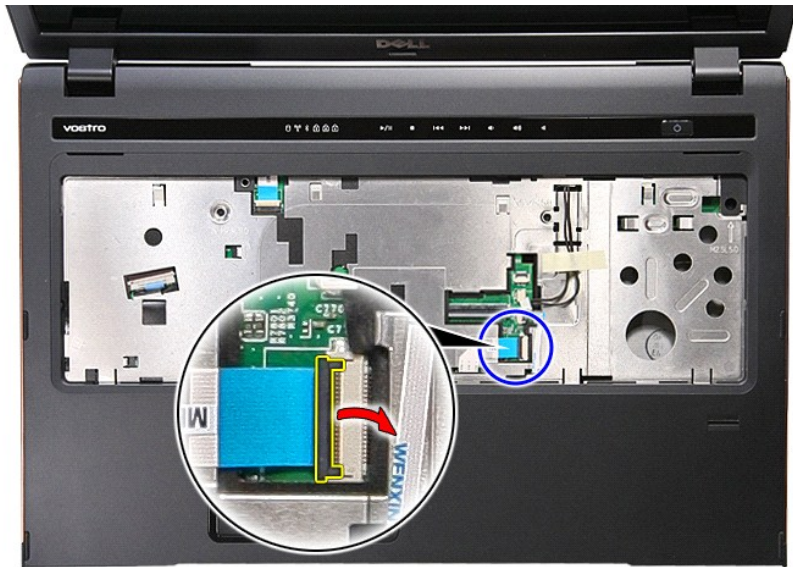

14. Disconnect the audio cable from its connector on the system board.

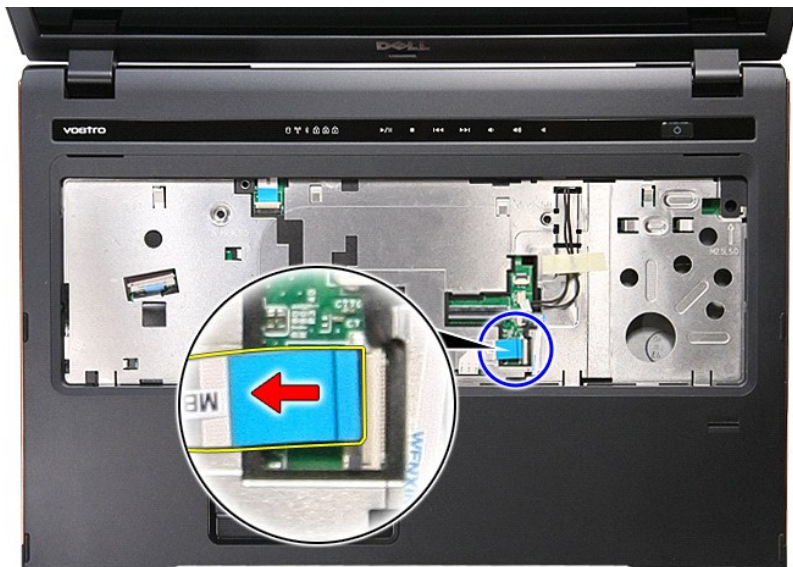

15. Open the clip that secures the touchpad data cable to its connector on the system board.



16. Disconnect the touchpad data cable from its connector on the system board.



17. Open the clip that secures the media button data cable to its connector on the system board.

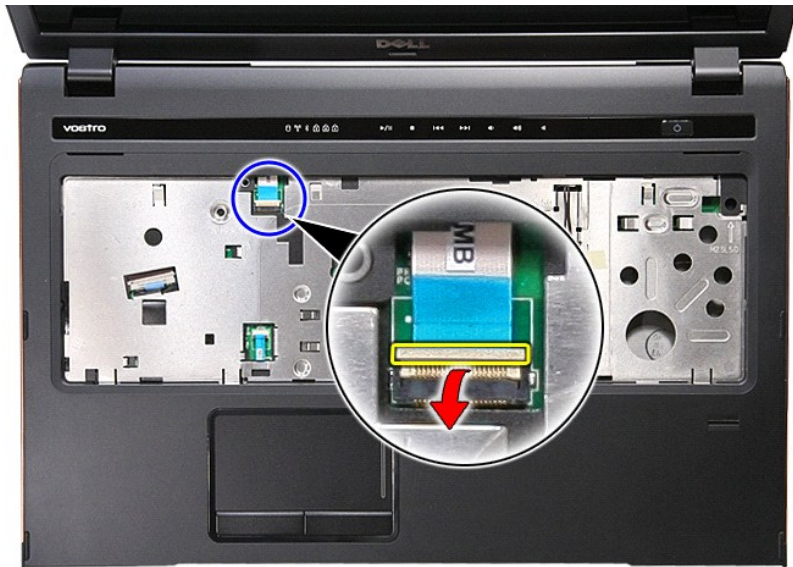

18. Disconnect the media button data cable from its connector on the system board.

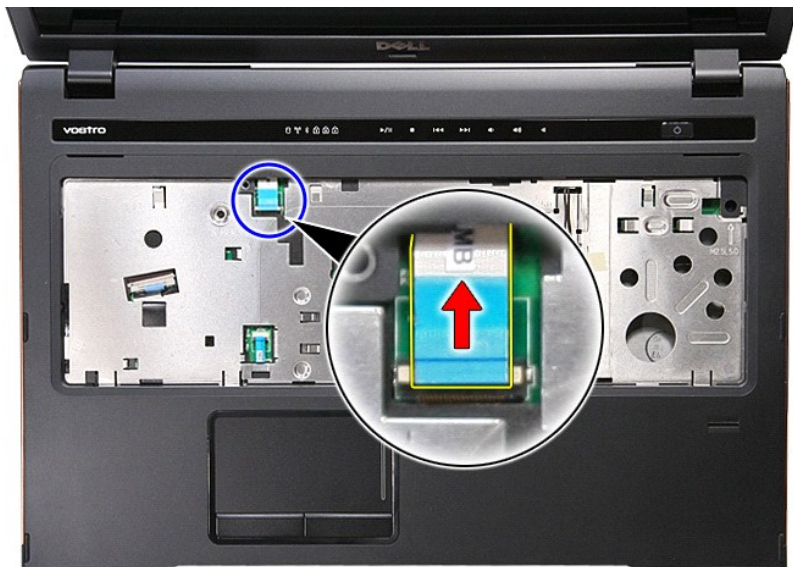

19. Remove the screws that secure the palm rest to the front of the computer.



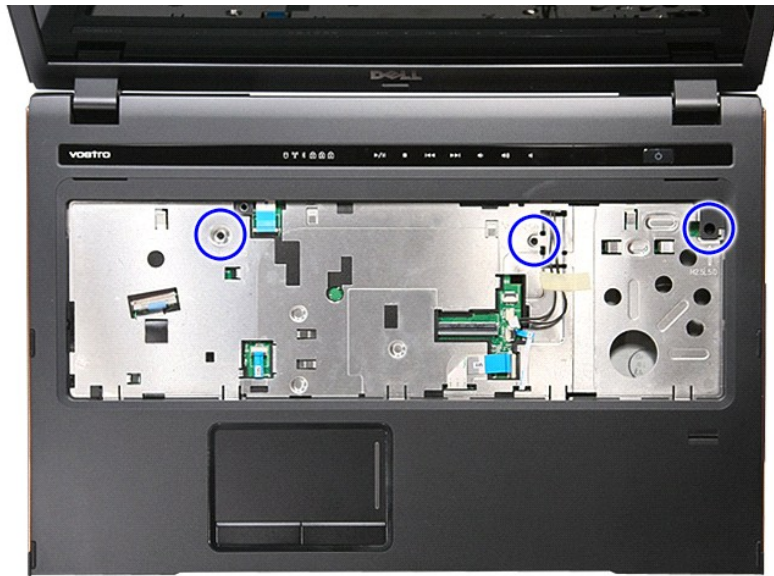

20. Gently pry along the edges of the palm rest to release the palm rest.



21. Lift the palm rest up and away from the computer.



## Replacing the Palm Rest

To replace the palm rest, perform the above steps in reverse order.

---

[Back to Contents Page](#)

[Back to Contents Page](#)

## Removing and Replacing Parts

Dell™ Vostro™ 3700 Service Manual

- [Battery](#)
  - [ExpressCard](#)
  - [Memory](#)
  - [Optical Drive](#)
  - [Wireless Local Area Network \(WLAN\) Card](#)
  - [Palm Rest](#)
  - [Bluetooth Card](#)
  - [Speakers](#)
  - [Display Bezel](#)
  - [Display Panel](#)
  - [ExpressCard Cage](#)
  - [Heat Sink](#)
  - [I/O Board](#)
  - [Memory Card](#)
  - [Base Cover](#)
  - [Hard Drive](#)
  - [Coin-Cell Battery](#)
  - [Keyboard](#)
  - [Audio Board](#)
  - [Power-Button Board](#)
  - [Display Assembly](#)
  - [Camera](#)
  - [Display Hinges](#)
  - [System Board](#)
  - [Processor](#)
- 

[Back to Contents Page](#)

[Back to Contents Page](#)

## Processor

Dell™ Vostro™ 3700 Service Manual

**WARNING:** Before working inside your computer, read the safety information that shipped with your computer. For additional safety best practices information, see the Regulatory Compliance Homepage at [www.dell.com/regulatory\\_compliance](http://www.dell.com/regulatory_compliance).

### Removing the Processor



1. Follow the procedures in [Before Working Inside Your Computer](#).
2. Remove the [battery](#).
3. Remove the [base cover](#).
4. Remove the [coin-cell battery](#).
5. Remove the [hard drive](#).
6. Remove the [optical drive](#).
7. Remove the [wireless local area network \(WLAN\) card](#).
8. Remove the [keyboard](#).
9. Remove the [palm rest](#).
10. Remove the [display assembly](#).
11. Remove the [ExpressCard cage](#).
12. Remove the [system board](#).
13. Remove the [heat sink and fan assembly](#).
14. Using a flat-blade screwdriver, rotate the cam screw counterclockwise to release the processor from its socket on the system board.

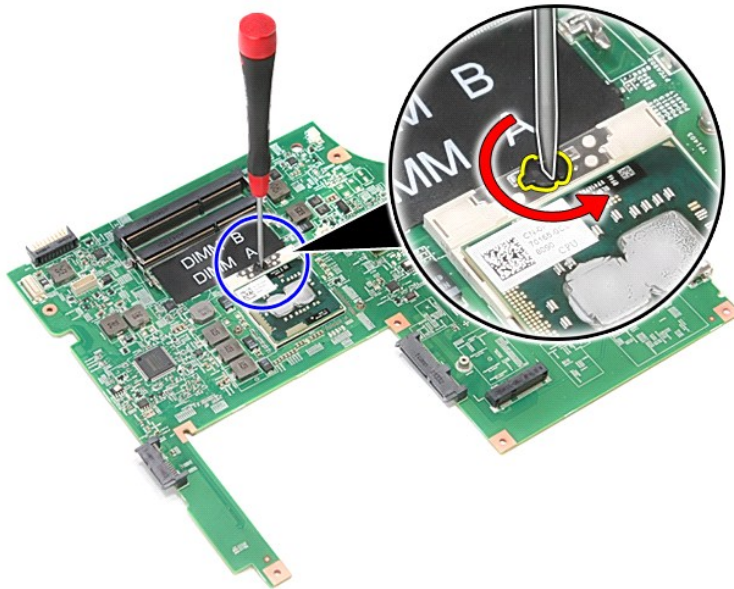

15. Lift the processor up and away from the system board.

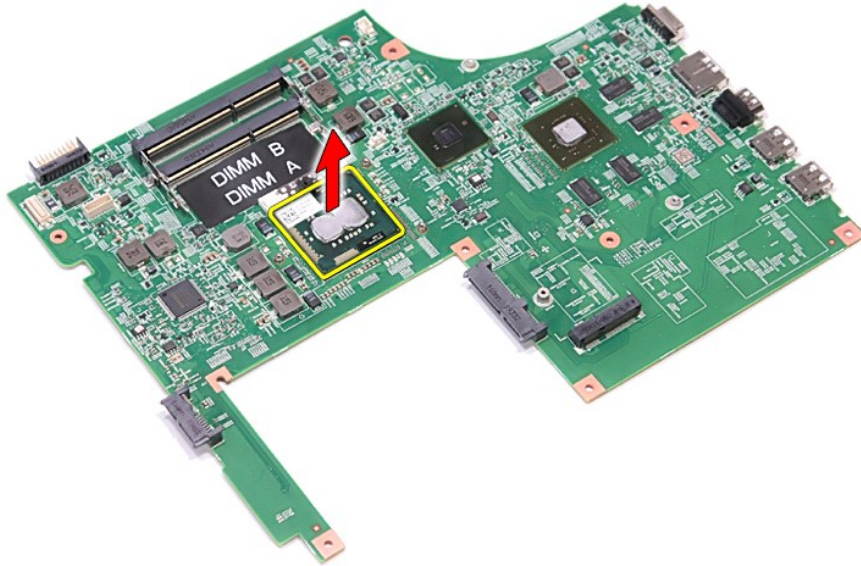

## Replacing the Processor

**CAUTION:** While replacing the processor, ensure that the cam lock is in the fully open position before seating the processor module. A processor module that is not properly seated can result in an intermittent connection or permanent damage to the microprocessor and ZIF socket.

To replace the processor, perform the above steps in reverse order.

---

[Back to Contents Page](#)

[Back to Contents Page](#)

## Power-Button Board

Dell™ Vostro™ 3700 Service Manual

**WARNING:** Before working inside your computer, read the safety information that shipped with your computer. For additional safety best practices information, see the Regulatory Compliance Homepage at [www.dell.com/regulatory\\_compliance](http://www.dell.com/regulatory_compliance).

---

### Removing the Power-Button Board



1. Follow the procedures in [Before Working Inside Your Computer](#).
2. Remove the [battery](#).
3. Remove the [base cover](#).
4. Remove the [hard drive](#).
5. Remove the [optical drive](#).
6. Remove the [keyboard](#).
7. Remove the [palm rest](#).
8. Remove the screw that secures the power-button board to the palm rest.



9. Open the clip that secures the power-button cable to its connector on the power-button board.

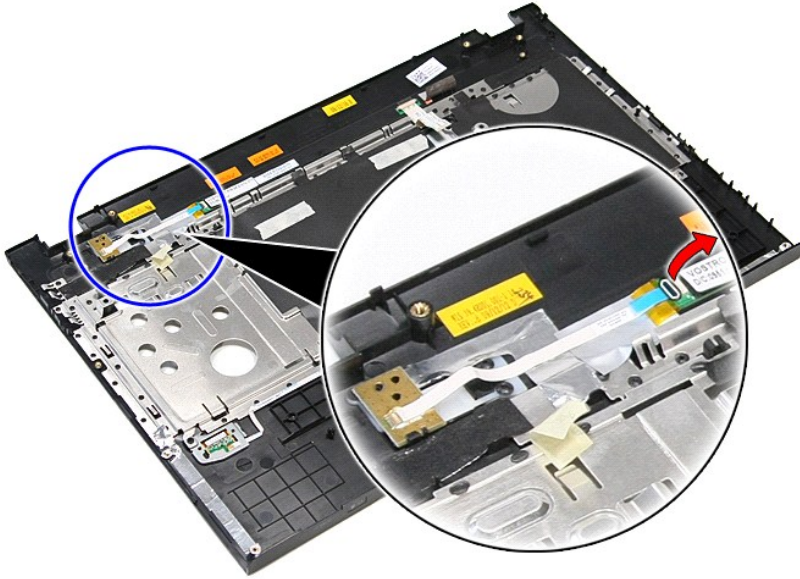

10. Disconnect the power-button cable from the power-button board.

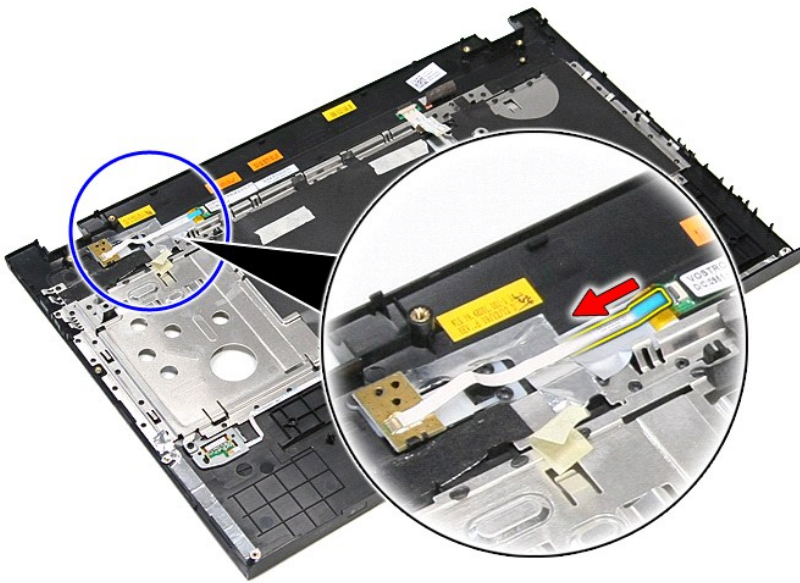

11. Lift the power-button board up and away from the computer.

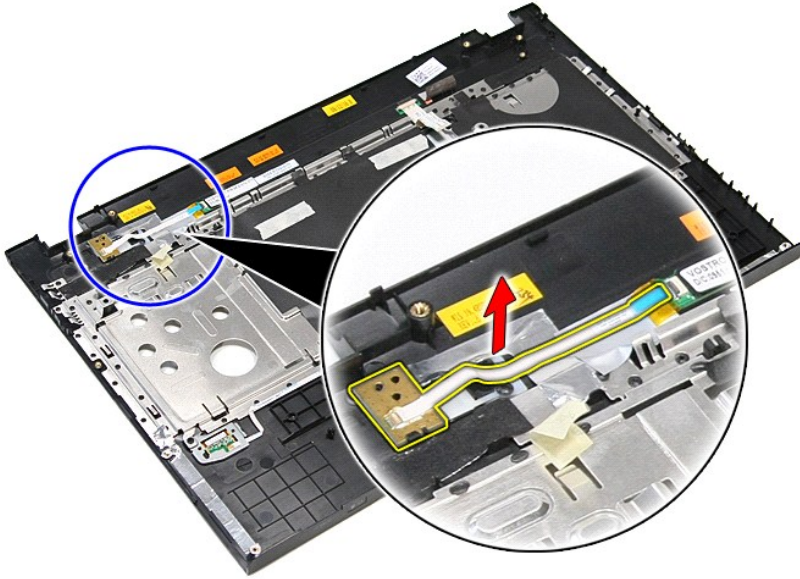

## Replacing the Power-Button Board

To replace the power-button board, perform the above steps in reverse order.

---

[Back to Contents Page](#)



[Back to Contents Page](#)

## Speakers

Dell™ Vostro™ 3700 Service Manual

**⚠ WARNING:** Before working inside your computer, read the safety information that shipped with your computer. For additional safety best practices information, see the Regulatory Compliance Homepage at [www.dell.com/regulatory\\_compliance](http://www.dell.com/regulatory_compliance).

---

### Removing the Speakers

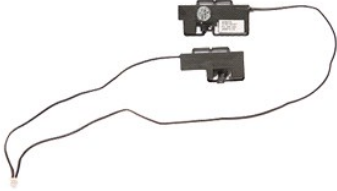

1. Follow the procedures in [Before Working Inside Your Computer](#).
2. Remove the [battery](#).
3. Remove the [base cover](#).
4. Remove the [hard drive](#).
5. Remove the [optical drive](#).
6. Remove the [keyboard](#).
7. Remove the [palm rest](#).
8. Remove the tape that secures the speaker cable to the front of the palm rest.

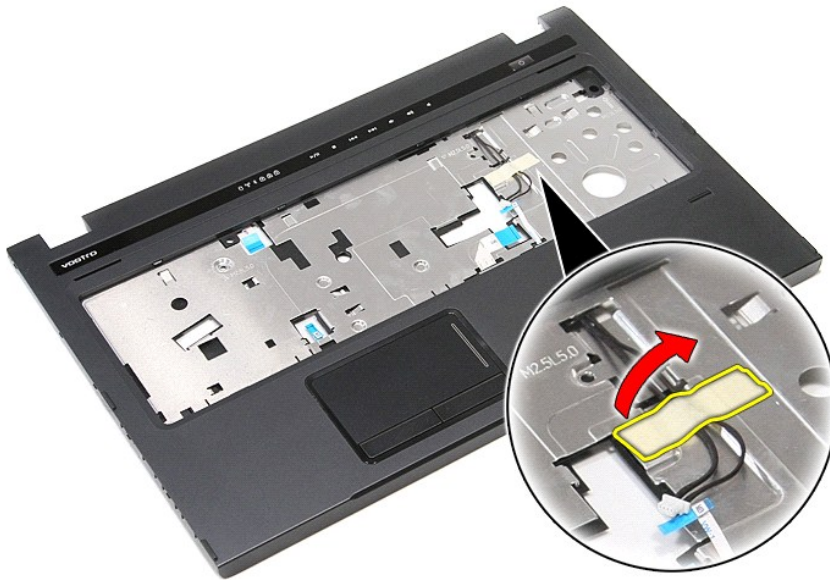

9. Remove the tapes that secure the speaker cables to the back of the palm rest.

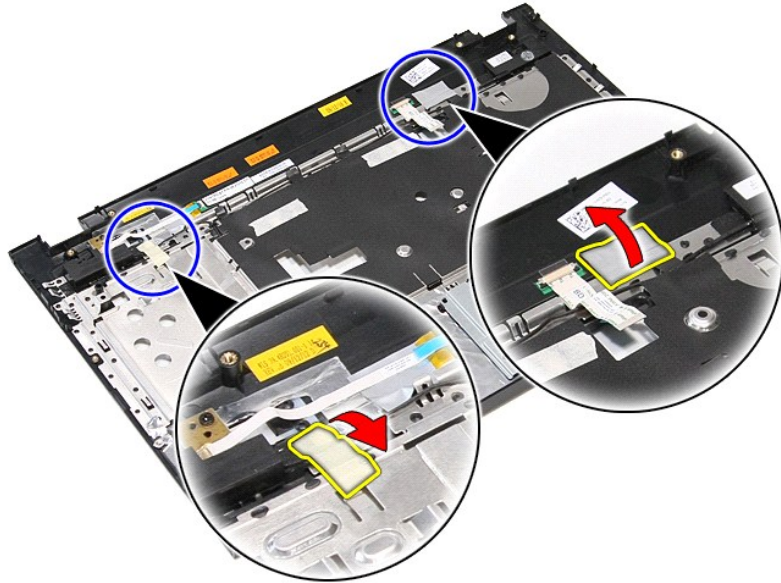

10. Remove the screws that secure the speakers to the palm rest.



11. Release the speakers from the palm rest.

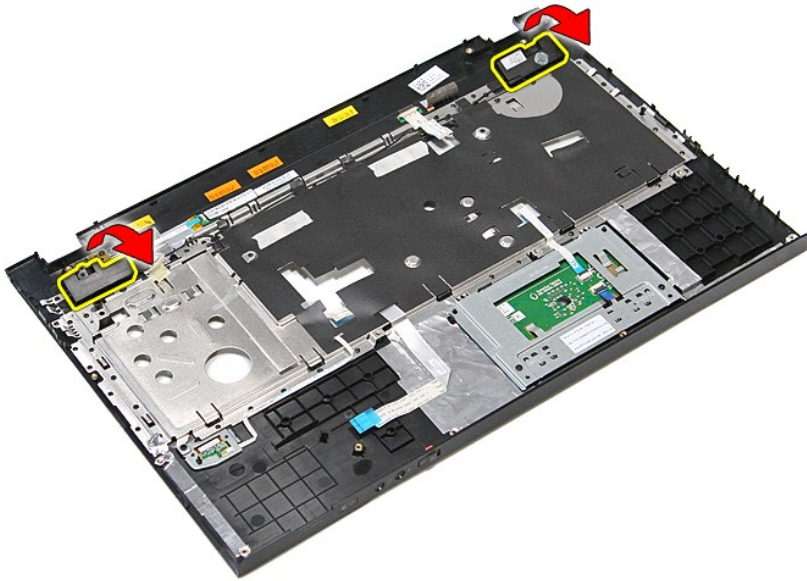

12. Release the speaker cables from their routing guides on the palm rest and remove the speakers from the palm rest.

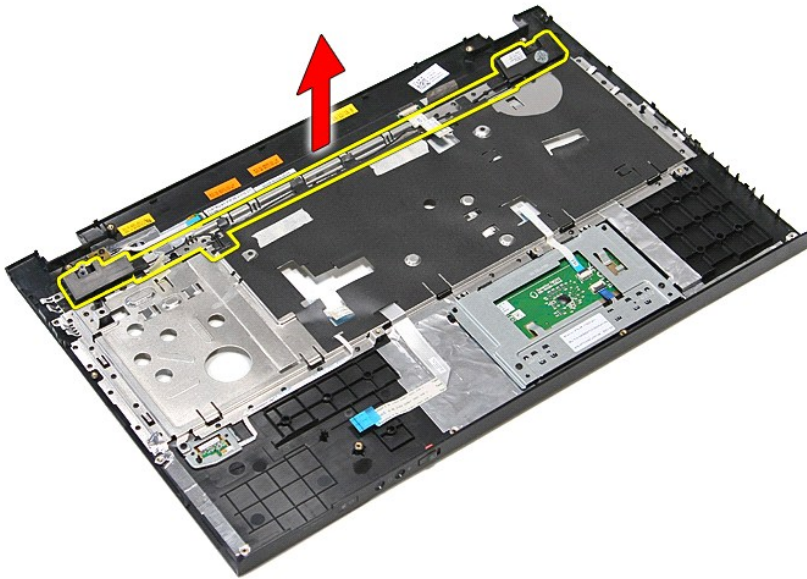

## Replacing the Speakers

To replace the speakers, perform the above steps in reverse order.

---

[Back to Contents Page](#)

[Back to Contents Page](#)

## Specifications

### Dell™ Vostro™ 3700 Service Manual

- [Communications](#)
- [Processor](#)
- [ExpressCard](#)
- [Keyboard](#)
- [System Information](#)
- [Battery](#)
- [Audio](#)
- [Touchpad](#)
- [AC Adapter](#)
- [Ports and Connectors](#)
- [Drives](#)
- [Video](#)
- [Physical](#)
- [Environmental](#)
- [Display](#)
- [Memory](#)

 **NOTE:** Offerings may vary by region. For more information regarding the configuration of your computer, click **Start→ Help and Support** and select the option to view information about your computer.

System Information	
Chipset	Intel® HM57
DRAM bus width	64 bits
Flash EPROM	4 MB
PCI-E bus	x16 PCI Express

Processor	
Types	Intel Core™ i3 series Intel Core i5 series Intel Core i7 series
L1 cache	32 KB per core
L2 cache	256 KB per core
L3 cache	up to 4 MB shared

Memory	
Type	DDR3 SDRAM
Speed	1066 MHz or 1333 MHz  <b>NOTE:</b> Intel Core i3/i5/i7 dual-core processors shipped with your computer support both 1066 Hz and 1333 MHz memory modules. However, the dual core processors will operate at 1066 MHz memory module only.
Connectors	two SODIMM slots
Module capacities	1 GB, 2 GB, or 4 GB
Minimum memory	1 GB
Maximum memory	8 GB
<b>NOTE:</b> Only 64-bit operating systems can detect memory capacities greater than 4 GB.	

Video	
Type	supports both integrated and discrete video
Controller	
Integrated	Intel Graphics Media Accelerator HD
Discrete	NVIDIA GeForce GT 330M
Output	15-pin VGA connector

Audio	
Type	two-channel high-definition audio codec (HDA)
Controller	IDT 92HD81
Speakers	two
Internal speaker amplifier	2 W channel
Volume controls	media control buttons, program menus

Communications	
Modem	supports external USB modem only (optional)
Network adapter	Realtek RTL8111TL

Wireless	wireless local area network (WLAN) Bluetooth®
----------	--------------------------------------------------

<b>ExpressCard</b>	
<b>NOTE:</b> The ExpressCard slot does NOT support PC Cards.	
ExpressCard connector	ExpressCard slot
Cards supported	34 mm ExpressCards

<b>Ports and Connectors</b>	
Audio	microphone connector, stereo headphone/speakers connector
Video	15-pin VGA connector 19-pin HDMI connector
IEEE 1394a	one 4-pin connector
Network adapter	RJ-45 connector
USB	four USB 2.0-compliant connector one eSATA/USB 2.0-compliant connector
Memory card reader	8-in-1 memory card reader
Mini-Card	PCI-E half-mini card support for WLAN

<b>Drives</b>	
Hard drive	SATA 2 HDD SATA 2 Mobile HDD
Optical drives	DVD+/-RW Blu-ray

<b>Display</b>	
Type	17.30-inch, anti glare (AG), true life (TL), high definition white light emitting diode (WLED)
Active area (X/Y)	381.89 mm x 214.81 mm
Dimensions	
Height	232.80 mm (9.17 inches)
Width	398.10 mm (15.67 inches)
Diagonal	431.80 mm (17.00 inches)
Maximum resolution	1600 x 900 at 262 K colors
Maximum brightness	200 nits
Operating angle	0° (closed) to 135°
Refresh rate	60 Hz
Viewing angles	
Horizontal	40/40
Vertical	10/30
Pixel pitch	0.23868 mm (0.01 inch)

<b>Keyboard</b>	
Number of keys	United States: 102 keys United Kingdom: 103 keys Brazil: 105 keys Japan: 106 keys
Layout	QWERTY/AZERTY/Kanji

<b>Touchpad</b>	
Active area:	
X-axis	90.00 mm
Y-axis	45.20 mm

<b>Battery</b>	
Type	6-cell "smart" lithium ion (2.6 AHr) 9-cell "smart" lithium ion (2.8 AHr)
Charge time with computer off	approximately 4 hours (on a fully discharged battery)
Operating time	battery operating time varies depending on operating conditions and can significantly reduce under certain power-intensive conditions.
Life span	approximately 300 charge/discharge cycles
Depth	

6-cell	57.80 mm (2.27 inches)
9-cell	57.80 mm (2.27 inches)
Height	
6-cell	20.80 mm (0.82 inch)
9-cell	40.15 mm (1.58 inches)
Width	
6-cell/9-cell	255.60 mm (10.06 inches)
Weight	
6-cell	340.00 g (0.75 lb)
9-cell	504.50 g (1.11 lb)
Voltage	11.10 VDC
Temperature range	
Operating	0 °C to 35 °C (32 °F to 95 °F)
Storage	-40 °C to 65 °C (-40 °F to 149 °F)
Coin-cell battery	3 V CR2032 lithium coin cell

<b>AC Adapter</b>	
Type	
Input voltage	100 VAC-240 VAC
Input current (maximum)	1.5 A
Input frequency	50 Hz-60 Hz
Output power	130 W
Output current	6.70 A (continuous)
Dimensions	
Depth	76.20 mm (3.00 inches)
Height	25.40 mm (1.00 inch)
Width	154.70 mm (6.09 inches)
Temperature range	
Operating	0 °C to 35 °C (32 °F to 95 °F)
Storage	-40 °C to 65 °C (-40 °F to 149 °F)

<b>Physical</b>	
Depth	271.00 mm (10.66 inches)
Height	26.80 mm-34.40 mm (1.05 inches-1.35 inches)
Width	410.8 mm (16.17 inches)
Weight	2.90 kg (6.39 lb) with a 6-cell battery and media drives

<b>Environmental</b>	
Temperature range:	
Operating	0 °C to 35 °C (32 °F to 95 °F)
Non-operating	-40 °C to ~65 °C (-40 °F to ~149 °F)
Relative humidity (maximum):	
Operating	10 % to 90 % (noncondensing)
Non-operating	20 % to 95 % (noncondensing)
Maximum vibration:	
Operating	0.66 Grms (2 Hz-600 Hz)
Non-operating	1.30 Grms (2 Hz-600 Hz)
<b>NOTE:</b> Vibration is measured using a random-vibration spectrum that simulates user environment.	
Maximum shock:	
Operating	110 G (2 ms)
Non-operating	160 G (2 ms)
<b>NOTE:</b> Shock is measured with hard drive in head-parked position and a 2 ms half-sine pulse.	



[Back to Contents Page](#)

## System Board

Dell™ Vostro™ 3700 Service Manual

**⚠ WARNING:** Before working inside your computer, read the safety information that shipped with your computer. For additional safety best practices information, see the Regulatory Compliance Homepage at [www.dell.com/regulatory\\_compliance](http://www.dell.com/regulatory_compliance).

---

### Removing the System Board

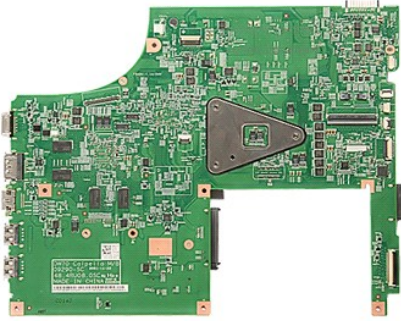

1. Follow the procedures in [Before Working Inside Your Computer](#).
2. Remove the [battery](#).
3. Remove the [base cover](#).
4. Remove the [coin-cell battery](#).
5. Remove the [hard drive](#).
6. Remove the [optical drive](#).
7. Remove the [wireless local area network \(WLAN\) card](#).
8. Remove the [memory](#).
9. Remove the [keyboard](#).
10. Remove the [palm rest](#).
11. Remove the [ExpressCard cage](#).
12. Remove the [display assembly](#).
13. Disconnect the DC-in cable from its connector on the system board.

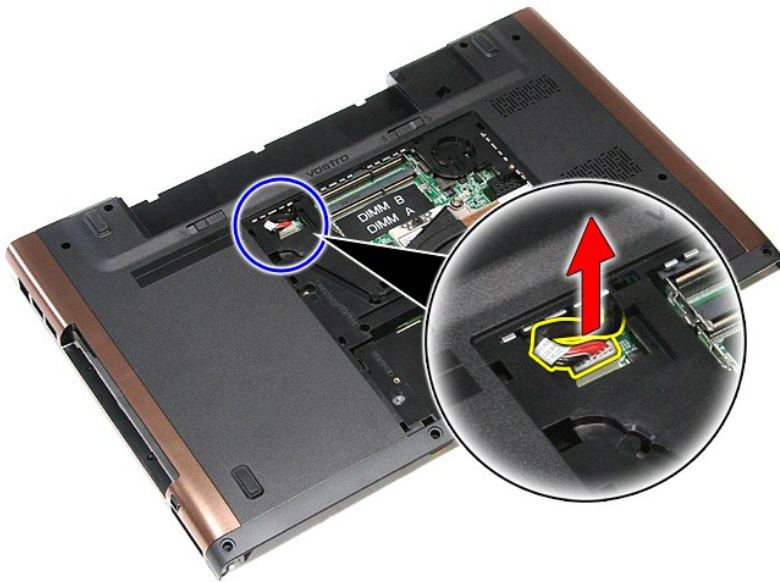

14. Remove the screws that secure the system board to the computer.



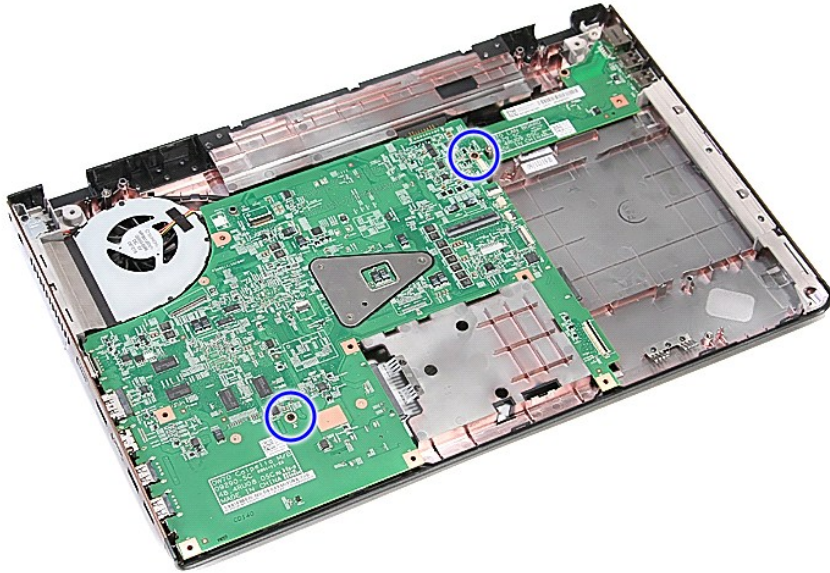

15. Gently lift the system board up and away from the computer.

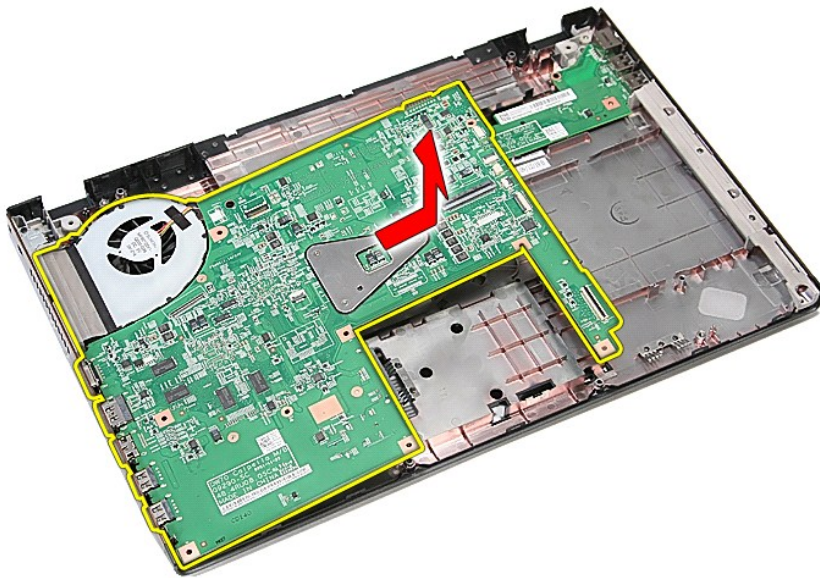

## Replacing the System Board

To replace the system board, perform the above steps in reverse order.

---

[Back to Contents Page](#)

[Back to Contents Page](#)

## Wireless Local Area Network (WLAN) Card

Dell™ Vostro™ 3700 Service Manual

**WARNING:** Before working inside your computer, read the safety information that shipped with your computer. For additional safety best practices information, see the Regulatory Compliance Homepage at [www.dell.com/regulatory\\_compliance](http://www.dell.com/regulatory_compliance).

### Removing the WLAN Card



1. Follow the procedures in [Before Working Inside Your Computer](#).
2. Remove the [battery](#).
3. Remove the [base cover](#).
4. Disconnect the antenna cables from the WLAN card.



5. Remove the screw that secures the WLAN card to the system board.



6. Gently pull the WLAN card away from its connector on the system board and remove it from the computer.



## Replacing the WLAN Card

To replace the WLAN Card, perform the above steps in reverse order.

---

[Back to Contents Page](#)

# Working on Your Computer

## Dell™ Vostro™ 3700 Service Manual

- [Before Working Inside Your Computer](#)
  - [Recommended Tools](#)
  - [Turning Off Your Computer](#)
  - [After Working Inside Your Computer](#)
- 

## Before Working Inside Your Computer

Use the following safety guidelines to help protect your computer from potential damage and to help to ensure your personal safety. Unless otherwise noted, each procedure included in this document assumes that the following conditions exist:

- 1 You have performed the steps in [Working on Your Computer](#).
- 1 You have read the safety information that shipped with your computer.
- 1 A component can be replaced or--if purchased separately--installed by performing the removal procedure in reverse order.

 **WARNING:** Before working inside your computer, read the safety information that shipped with your computer. For additional safety best practices information, see the Regulatory Compliance Homepage at [www.dell.com/regulatory\\_compliance](http://www.dell.com/regulatory_compliance).

 **CAUTION:** Many repairs may only be done by a certified service technician. You should only perform troubleshooting and simple repairs as authorized in your product documentation, or as directed by the online or telephone service and support team. Damage due to servicing that is not authorized by Dell is not covered by your warranty. Read and follow the safety instructions that came with the product.

 **CAUTION:** To avoid electrostatic discharge, ground yourself by using a wrist grounding strap or by periodically touching an unpainted metal surface, such as a connector on the back of the computer.

 **CAUTION:** Handle components and cards with care. Do not touch the components or contacts on a card. Hold a card by its edges or by its metal mounting bracket. Hold a component such as a processor by its edges, not by its pins.

 **CAUTION:** When you disconnect a cable, pull on its connector or on its pull-tab, not on the cable itself. Some cables have connectors with locking tabs; if you are disconnecting this type of cable, press in on the locking tabs before you disconnect the cable. As you pull connectors apart, keep them evenly aligned to avoid bending any connector pins. Also, before you connect a cable, ensure that both connectors are correctly oriented and aligned.

 **NOTE:** The color of your computer and certain components may appear differently than shown in this document.

To avoid damaging your computer, perform the following steps before you begin working inside the computer:

1. Ensure that your work surface is flat and clean to prevent the computer cover from being scratched.
2. Turn off your computer (see [Turning Off Your Computer](#)).
3. If the computer is connected to a docking device (docked) such as the optional Media Base or Battery Slice, undock it.

 **CAUTION:** To disconnect a network cable, first unplug the cable from your computer and then unplug the cable from the network device.

4. Disconnect all network cables from the computer.
5. Disconnect your computer and all attached devices from their electrical outlets.
6. Close the display and turn the computer upside-down on a flat work surface.

 **CAUTION:** To avoid damaging the system board, you must remove the main battery before you service the computer.

7. Remove the main battery (see [Battery](#)).
8. Turn the computer top-side up.
9. Open the display.
10. Press the power button to ground the system board.

 **CAUTION:** To guard against electrical shock, always unplug your computer from the electrical outlet before opening the display.

 **CAUTION:** Before touching anything inside your computer, ground yourself by touching an unpainted metal surface, such as the metal at the back of the computer. While you work, periodically touch an unpainted metal surface to dissipate static electricity, which could harm internal components.

11. Remove any installed ExpressCards or Smart Cards from the appropriate slots.
12. Remove the hard drive (see [Hard Drive](#)).

## Recommended Tools

The procedures in this document may require the following tools:

- 1 Small flat-blade screwdriver
- 1 #0 Phillips screwdriver
- 1 #1 Phillips screwdriver
- 1 Small plastic scribe
- 1 Flash BIOS update program CD

## Turning Off Your Computer

 **CAUTION:** To avoid losing data, save and close all open files and exit all open programs before you turn off your computer.

1. Shut down the operating system:

1 In Windows Vista®:

Click **Start** , then click the arrow in the lower-right corner of the **Start** menu as shown below, and then click **Shut Down**.



1 In Windows® XP:

Click **Start** → **Turn Off Computer** → **Turn Off**.

The computer turns off after the operating system shutdown process is complete.

2. Ensure that the computer and all attached devices are turned off. If your computer and attached devices did not automatically turn off when you shut down your operating system, press and hold the power button for about 6 seconds to turn them off.

---

## After Working Inside Your Computer

After you complete any replacement procedure, ensure you connect any external devices, cards, and cables before turning on your computer.

 **CAUTION:** To avoid damage to the computer, use only the battery designed for this particular Dell computer. Do not use batteries designed for other Dell computers.

1. Connect any external devices, such as a port replicator, battery slice, or media base, and replace any cards, such as an ExpressCard.

 **CAUTION:** To connect a network cable, first plug the cable into the network device and then plug it into the computer.

2. Connect any telephone or network cables to your computer.
3. Replace the [battery](#).
4. Connect your computer and all attached devices to their electrical outlets.
5. Turn on your computer.

---

[Back to Contents Page](#)